



# OEM CATALOGUE

*Edition One*

# WELCOME



We are thrilled to share some exciting news with you! Miriad Products and Quest Leisure, two of the most trusted names in the recreational vehicle and outdoor leisure trade, are re-branding to form a new and fresh look.

At MQL, our mission is

***To support the recreational vehicle and outdoor leisure industry with exceptional service, innovation and reliability. To foster strong relationships with suppliers and retailers, continuously seeking innovative solutions to meet the evolving needs of the industry and be the first-choice supplier within the industry.***

## CONTACT US

MQL Miriad Quest Limited  
Dovefields Industrial Estate  
Uttoxeter  
Staffordshire  
ST14 8HU

[sales@mql.co.uk](mailto:sales@mql.co.uk)

# CONTENTS

## Information

Welcome pages, contact us information and contents page 1 - 3

## Heating & Cooling

Diesel heaters, combi heaters, electric heaters, underfloor heaters, air conditioners and accessories 4 - 18

## Refrigeration

Fridges, freezers, fridge freezers, spare parts and accessories 19 - 31

## Cookware

Gas and electric hobs, hob and sink units, gas and electric ovens, microwaves, extractors and induction hobs 32 - 37

## Water

Water heaters, boilers, water outlets, shower outlets, water pumps, submersible pumps, shower trays, sinks, taps, plumbing, water tanks and accessories 38 - 58

## Electrical

Lighting, inverters, chargers, batteries, solar panels, generators, probes, control systems, supply units, power management, 12V & 230V inlets and outlets, USB power, sockets and all electrical items. 59 - 87

## Gas

Valves, pipes, regulators, pig tails, hoses, connectors, adapters, switches, BBQ points and gas accessories. 88 - 93

## Cleaning & Sanitation

Toilets, porta potti's and service doors 94 - 97

## Furniture & Fixings

Trim, push locks, door fittings, handles, tambour doors, table legs plus supports, window blinds and curtains 98 - 110

## Windows & Rooflights

Windows, fitted blinds, rooflights, fixings and roof vents. 111 - 119

## Vehicle Accessories

Swivel bases, thermal screens, beds, ladders, seat frames, vehicle steps, multi-rails and bike racks 120 - 134

## TV & Satellite

Portable WIFI, Satellites, TV brackets 135 - 136

## Household

Gas detectors, carbon monoxide detectors, fire extinguishers and smoke alarms. 137

## Awnings & Tents

Wind out canopies, drive away awnings, static awnings, tailgate awnings, screen houses, canopies, windbreaks and Skypod 138 - 155

# Heating & Cooling



**All parts required for the installation are provided by Yilkar:**

- Air Heater
- Air routing hose kit
- Air inlet / outlet vent kit
- Main wiring
- Vibration-absorbing seal
- Combustion and exhaust air clamp kit
- Combustion air hose
- Exhaust air hose
- Polyamide fuel hose
- Fuel metering pump
- Vibration damper pump connection kit
- Fuel filter kit
- Fuel pull hose kit

## Yilkar Air Heater – YH2 comfort kit

**305.01.YH.200.01DL**

- Chrome Frame
- 1.23 Inch Oled Large Graphic Display
- 4 button control
- Ambient Temperature Sensor, Altitude Sensor
- Internal Battery
- Weekly Programming Opportunity
- Eco, Normal, Max Working Power
- Unit Support, Language Support
- Sleep Mode, Warning Display
- Fuel Consumption: 0,28 lt/h (max.) - 0,2 lt/h
- Operating Voltage: 12 / 24V DC
- Starting Current: 8A @ 12V DC - 4A @ 24V DC
- Operating Current: (max.) 3A @ 12V DC - 1.5A @ 24V DC
- Heating Capacity: 0,9 - 2,5 kW
- Air Flow: 90 m<sup>3</sup>/h (max.)
- Fuel Type: Diesel
- Weight: 3 kg



**All parts required for the installation are provided by Yilkar:**

- Air Heater
- Air routing hose kit
- Air inlet / outlet vent kit
- Main wiring
- Vibration-absorbing seal
- Combustion and exhaust air clamp kit
- Combustion air hose
- Exhaust air hose
- Polyamide fuel hose
- Fuel metering pump
- Vibration damper pump connection kit
- Fuel filter kit
- Fuel pull hose kit
- YH Basic control unit

## Yilkar Air Heater – YH2 standard kit

**305.01.YH200.01**

- 0.97 inch Oled Large Graphic Display
- 4 Button Control
- Ambient Temperature Sensor
- Adjustable Temperature
- Heating Mode
- Ventilation Mode
- Instant Temperature Display
- Unit Support , Warning Display , Reset
- Altitude limit 1500m
- Fuel Consumption: 0,28 lt/h (max.) - 0,2 lt/h
- Operating Voltage: 12 / 24V D C
- Starting Current: 8A @ 12V DC - 4A @ 24V DC
- Operating Current: (max.) 3A @ 12V DC - 1.5A @ 24V DC
- Heating Capacity: 0,9 - 2,5 kW
- Air Flow: 90 m<sup>3</sup>/h (max.)
- Fuel Type: Diesel
- Weight: 3 kg



## Yilkar external VW T6/T6.1 diesel heater bracket

**31.101.11.01801.28**

- Bracket for Yilkar air heaters

# YILKAR

# Heating & Cooling



## Eberspächer AS3 diesel heater Kits Available for various vehicles

- Extremely fast interior heating
- High efficiency, direct heating
- Extremely low fuel and electricity consumption
- Compact design & quiet operation
- Automatic interior temperature control
- Space saving, external installation
- Flexible installation with 90° tilt possible to either side
- Connects to the vehicle's fuel tank using dedicated pickup kit
- 2.2kW heating capacity
- Long life brushless motor (up to 5000 hours)
- Battery under-voltage protection
- Heater over-voltage protection
- Fully type approved



Eberspächer



### Internal kit VW T5/T5.1/T6/T6.1

**29.2113.30.0005**

- Airtronic S3 D2L diesel heater (12V)
- Mount bracket for internal installation
- Easy-start Pro controller
- Wiring loom for battery
- Fuel pipe with tank pickup
- 1 metre exhaust
- Ducting and associated fittings included
- 1 x hot air outlet

### External Kit VW T5/T5.1/T6/T6.1

**29.2113.30.0006**

- Airtronic S3 D2L diesel heater (12V)
- Easystart Pro Controller
- External mounting plate
- Combustion air inlet ducting
- Exhaust ducting and silencer
- Hot air ducting and panel mount outlet
- Wiring harness and fittings
- VW T5/T6 fuel pickup kit
- Fuel metering pump, holder, pipework and wiring harness
- All accessories, fittings, clips & clamps

### External Kit Ford Transit custom

**29.2113.30.0040**

- Airtronic S3 D2L diesel heater (12V)
- Easystart Pro Controller
- External mounting plate
- Combustion air inlet ducting
- Exhaust ducting and silencer
- Wiring harness and fittings
- Hot air ducting and panel mount outlet
- Ford Transit Custom fuel pickup kit
- Fuel metering pump, holder, pipework and wiring harness
- All accessories, fittings, clips & clamps

### External Kit NEW Ford Transit custom

**29.2113.30.0057**

- Airtronic S3 D2L diesel heater (12V)
- Easystart Pro Controller
- External mounting plate
- Combustion air inlet ducting
- Exhaust ducting and silencer
- Wiring harness and fittings
- Hot air ducting and panel mount outlet
- Ford Transit Custom fuel pickup kit
- Fuel metering pump, holder, pipework and wiring harness
- All accessories, fittings, clips & clamps

**01283 586060**

**sales@mql.co.uk**

**5**

# Heating & Cooling



## Truma Combi & Combi D Heaters

**All Truma combi packs below include a black flue kit**

### **Combi 2E & CP+ Controller: 33113-80MB/L**

- Includes: Truma combi 2E LPG gas and 230v electric unit, CP+ digital control panel, JG water kit
- Ducting & outlets sold separately

### **Combi 4E & CP+ Controller: 33713-80MB/L**

- Includes: Truma combi 4E LPG gas and 230v electric unit, CP+ digital control panel, JG water kit
- Ducting & outlets sold separately

### **Combi 4E & iNet X Controller: 33713-78MX/L**

- Includes: Truma combi 4E LPG gas and 230v electric unit, iNetX control panel, JG water kit
- Ducting & outlets sold separately

### **Combi 6E & CP+ Controller: 33813-80MB/L**

- Includes: Truma combi 6E LPG gas and 230v electric unit, CP+ digital control panel, JG water kit
- Ducting & outlets sold separately

### **Combi 6E & iNet X Controller: 33813-78MX/L**

- Includes: Truma combi 6E LPG gas and 230v electric unit, iNetX control panel, JG water kit
- Ducting & outlets sold separately

## Diesel Combi's

### **Diesel Combi D4E & iNet X Controller: 33416-78UKSP**

- Includes: Truma combi D4E diesel and 230v electric unit, iNetX control panel, JG water kit
- Ducting & outlets sold separately

### **Diesel Combi D6E & iNet X Controller: 33516-78/UKSP**

- Includes: Truma combi D6E diesel and 230v electric unit, iNetX control panel, JG water kit
- Ducting & outlets sold separately



### CP+ Controller

- Program water or room temperature with the time switch, intuitive operation.
- Automatic climate control (only if used with Truma air conditioner)



### Truma window switch

**34030-34700**

- Automatically switches off combi if window is opened.



### iNet X Controller

- Clear 4.3" colour touch display.
- Control all your appliances with just one device.
- Bluetooth enabled for smartphone control.

# Heating & Cooling



Truma Eezy electric heater

**39200-03**

330 x 188 x 123 mm

- 100% electric: Purely electric heating (230 V)
- Safe: The specially approved Truma solution for recreational vehicles
- Can be cleverly integrated into furniture
- Flexible: Direct warm air outlet or with warm air distribution
- Simple: Quick installation, intuitive operation, no maintenance costs
- Weight: 2.6 kg



Eberspacher electric heater

**29.2120.30.0000**

134 x 207 x 186.6 mm

- Ensures a pleasant, comfortable controlled temperature
- Features a durable, quiet fan with variable speed operation
- Thanks to a modular design and compact dimensions, the installation position can be varied according to vehicle interior and targeted heating
- Weight: 1.45 kg



Widney 700w plinth fan heater

**PH700**

218 x 110 x 280 mm

- 700 Watts
- Under bench fan heater

# Heating & Cooling



Truma VarioHeat blown air heater  
CP+ controller

37401-01 : Eco

37501-01 : Comfort

- High-performance compact heater for vans, motorhomes and caravans.
- New generation of heaters with progressive Truma technology
- Heat your vehicle quickly and reliably using the 3 output levels
- Includes CP+ control panel
- **Eco:** Voltage: 12v , Wattage: 2800w , Gas pressure : 30mbar
- **Comfort:** Voltage: 12v , Wattage: 3700w , Gas pressure : 30mbar
- Wall cowl, ducting and vents sold seperately



Truma VarioHeat comfort blown air heater  
Classic controller

37400-02 : Eco

37500-02 : Comfort

- High-performance compact heater for vans, motorhomes and caravans
- Contains progressive Truma technology, helping the heater to perform excellent for longer periods.
- Heat your vehicle quickly and reliably using the 3 output levels
- **Eco:** Voltage: 12v , Wattage: 2800w , Gas pressure : 30mbar
- **Comfort:** Voltage: 12v , Wattage: 3700w , Gas pressure : 30mbar
- Wall cowl, ducting and vents sold seperately



Truma wall cowl with ducting

39190-04

- Truma wall cowl suitable for a wall thickness of 20mm, cowl outer part sold separately.
- Kit consists of :
  - 2 x exhaust ducting
  - Wall mount
  - P clip
  - 4 x Jubilee clips

*Please note , this kit requires a cowl outer which is purchased seperately (see items below)*

Truma varioheat outer wall cowl cover

39050-00464 : Cream

39050-00465 : Black

39050-00466 : Bianca

- Truma original part.
- Wall cowl outer for use with the 39190-04 ducting
- Available in 3 colours





# Heating & Cooling



Truma lamella insert

**40721-05 : Black**

- Truma blown air heater lamella inset fitting
- To fit 65mm ducting



Truma lamella insert

**40721-01 : Agate grey**

- Truma blown air heater lamella inset fitting
- To fit 65mm ducting



Truma lamella insert

**40721-02 : Beige**

- Truma blown air heater lamella inset fitting
- To fit 65mm ducting



Truma swivel air outlet SCW-2

**39971-01 : Black**

- Blown air heating swivel air outlet scw
- Swivelling non-closable outlet
- 80mm outlet



Truma swivel air outlet SCW-2

**39971-02 : Beige**

- Blown air heating swivel air outlet SCW
- Swivelling non-closable outlet
- 80mm outlet



End outlet (long)

**40171-25 : Black**

- End outlet
- Suitable for 65mm ducting



End air outlet

**40171-51 : Agate grey**  
**40171-55 : Black**

- End air outlet
- Suitable for 65mm ducting



End air outlet

**40171-52 : Beige**  
**40171-53 : Brown**

- End air outlet
- Suitable for 65mm ducting



End air outlet

**40171-54 : Grey**  
**40171-56 : White**

- End air outlet
- Suitable for 65mm ducting

# Heating & Cooling



Truma blanking plug  
VD-Combi

**34310-01**

- Special extended shaped blanking plug for use with Truma combi boiler this allows you to blank off one of the outlets on the Truma combi boilers



Truma blanking plug VD

**40353-01 : Agate grey**

- Blanking plug vd for closing a warm air outlet



Truma US clip

**40241-51**

65 mm

- Suitable for 65mm ducting



Truma US clip

**39590-51**

80 mm

- For holding the heating pipe/air hose firmly against the floor or wall
- For use with 80mm ducting Truma heaters
- For use with the VR80 air ducting



Truma 65-35mm reducer

**40381-01**

- For reducing 65mm ducting down to 35mm ducting.



Truma outlet nut

**40181-51 : Agate grey**

- Truma outlet nut agate grey, for 65mm ducting



T Piece use with outlet

**40151-52 : Grey**

- Used to install in-line outlets



Straight coupling connector  
UM

**40161-51 : Agate grey**

- Joins two lengths of 65mm ducting together

# Heating & Cooling



**Truma BG elbow 65/72 mm**

**40740-51 : Black**

- Designed for use with 65 or 72 mm air ducting.
- 65 mm air ducting goes on the inside of the elbow and 72 mm goes on the outside.



**Truma BG elbow 80 mm**

**39490-00 : Black**

- Designed for use with 80mm air ducting



**T-piece 65/72 mm**

**40151-51 : Agate grey**

- Designed for use with 65 or 72 mm air ducting.
- 65 mm air ducting goes on the inside of the T piece and 72 mm goes on the outside.



**Truma Y pipe 65/72 mm**

**40191-51 : Agate grey**

- Designed for use with 65 or 72 mm air ducting.
- 65 mm air ducting goes on the inside of the Y piece and 72 mm goes on the outside.



**Reducing T-Piece  
80 to 65/72 mm**

**39541-01 : Black**

- Designed for 80 mm inlet to 65 or 72 mm outlets
- 65 mm air ducting goes on the inside of the T piece and 72 mm goes on the outside.



**Truma insulated air ducting  
65 mm (order in 20m)**

**40230-00**

- Truma ducting for warm air heating
- Ideal for Truma, Whale and Propex combis
- 65 mm outside diameter
- Order in 20m lengths



**Truma insulated air ducting  
80 mm (order in 20m)**

**39450-01**

- Truma ducting for warm air heating
- 80 mm outside diameter
- Order in 20m lengths

# Heating & Cooling



**Whale Air 3kw underfloor gas heater**

**SETSL3511A**

175 x 165 x 469 mm

- The Whale Heat Air 3GT 3KW Space Heater is a powerful and lightweight gas heater designed for campervans. The heater is installed underfloor, so valuable on-board space is not lost.
- Product contents:
  - 1 x Gas heater
  - 1 x Control panel
  - 1 x LIN cable and connector
  - 1 x Combustion air intake flue
  - 1 x Combustion air intake silencer
  - 1 x Combustion air intake clamp
  - 1 x Exhaust gas flue and
  - 1 x Exhaust gas flue clamp
  - 2 x Exhaust gas flue brackets 60mm, 80mm
  - 1 x Exhaust gas flue end terminal bracket 100mm
  - 2 x Ducting reducer 90-65



**Whale Air 5kw underfloor gas & electric heater**

**SETSL5512A**

175 x 165 x 559 mm

- The Whale Heat Air 5GTE 5KW Space Heater is a powerful and lightweight gas and electric heater designed for caravans, motorhomes and campervans.
- Product contents:
  - 1 x Gas and Electric Heater
  - 1 x Control panel
  - 1 x LIN cable and connector
  - 1 x Combustion air intake flue
  - 1 x Combustion air intake silencer
  - 1 x Combustion air intake clamp
  - 1 x Combustion air intake bracket 60mm
  - 1 x Exhaust gas flue
  - 1 x Exhaust gas flue clamp
  - 3 x Exhaust gas flue brackets 40mm, 60mm, 80mm
  - 1 x Exhaust gas flue end terminal bracket 100mm
  - 1 x Heater Z - mounting bracket
  - 1 x Heater isolation mounts
  - 1 x Heater bracket screw kit

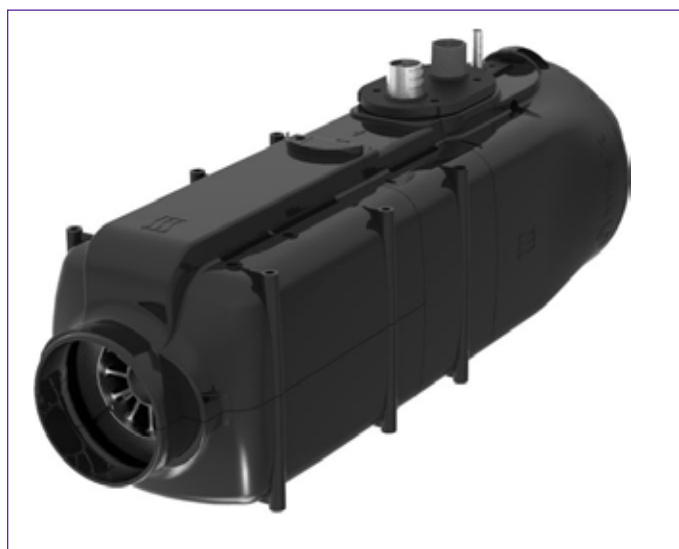

**Whale Air 6kw underfloor gas & electric heater**

**SETSL7512A**

175 x 165 x 559 mm

- The Whale Heat Air 6GTE 6KW Space Heater is a powerful and lightweight gas and electric heater designed for caravans, motorhomes and campervans.
- Product contents:
  - 1 x Gas and Electric Heater
  - 1 x Control panel
  - 1 x LIN cable and connector
  - 1 x Combustion air intake flue
  - 1 x Combustion air intake silencer
  - 1 x Combustion air intake clamp
  - 1 x Combustion air intake bracket 60mm
  - 1 x Exhaust gas flue
  - 1 x Exhaust gas flue clamp
  - 3 x Exhaust gas flue brackets 40mm, 60mm, 80mm
  - 1 x Exhaust gas flue end terminal bracket 100mm
  - 1 x Heater Z - mounting bracket
  - 1 x Heater isolation mounts
  - 1 x Heater bracket screw kit

# Heating & Cooling



**Whale VW T6/T6  
heater bracket**

**AK1818B**

- Whale original part.
- The Whale HeatAir 3GT VW T5/T6 bracket
- It is a replacement Whale HeatAir gas underslung vehicle mounting made for the Whale HeatAir 3GT space heater and designed for the T5/T6 van conversions and motorhomes.



**Whale Z undefloor underfloor  
heater bracket**

**AK1819B**

- Whale original part.
- Z bracket for Whale Heat Air Underfloor Space Heater Heat Air GT3



**Whale Custom underfloor  
heater bracket**

**AK1820B**

- The Whale HeatAir Ford Transit Custom Bracket is a replacement Whale HeatAir gas underslung vehicle mounting made for the Whale HeatAir 3GT space heater and designed for smaller van conversions and motorhomes.



**Whale 65mm ducting straight**

**DX6502B**

- Whale original part.
- Whale Straight Duct Fitting 65mm.



**Whale 65mm ducting t piece**

**DX6503B**

- Whale original part.
- Whale T Duct Fitting 65mm.



**Whale 65mm ducting end stop**

**DX6501B**

- Whale original part.
- Whale 65mm End Cap Fitting



**Whale 65mm ducting y piece**

**DX6504B**

- Whale original part.
- Whale Y Duct Fitting 65mm.



**Whale 90mm y piece**

**DX9010B**

- Whale original part.
- Y piece ducting connector for use in air heating systems.
- 90 x 90 mm.

# Heating & Cooling



**Whale 90x65x90mm ducting branch**

**DX9011B**

- Whale original part.
- Y branch ducting connector for use with air heating systems.
- 90 x 90 x 65 mm.



**Whale 90mm elbow**

**DX9012B**

- Whale original part.
- Elbow ducting connector for use with air heating systems.
- 90 x 90 mm.



**Whale 90-65mm reducer**

**DX9013B**

- Whale original part.
- Reducer fitting allowing connection between 90mm and 60mm ducting in air heating systems. Useful where a secondary ducting route only allows the smaller pipe.



**Whale 90mm straight**

**DX9014B**

- 90mm ducting connector for joining two pieces of 90mm warm air ducting in air heating systems. Suitable for replacing a section of damaged pipe, or to create an easily-removable joint in the system.



**Whale 90mm grill**

**DX9015B**

- Whale original part.
- 90mm air duct fixed grill



**Whale 65mm directional vent**

**DX6511B : Beige**  
**DX6521B : White**

**DX6531B : Black**  
**DX6541B : Grey**

- Whale original part.
- Whale 65mm directional vent, available in 4 different colours.



**Whale 65mm fixed vent**

**DX6516B: Beige**  
**DX6526B: White**

**DX6536B: Black**  
**DX6546B: Grey**

- Whale original part.
- Whale 65mm fixed vent, available in 4 different colours.

# Heating & Cooling

# DOMETIC



## Dometic FJX4 roof air conditioner

**9600050999 : 1500 Black**  
**9600051001 : 1700 Black**  
**9600051003 : 2200 Black**  
**9600051000 : 1700 White**  
**9600051002 : 2200 White**

752 X 225 X 702 mm

- Cools and dehumidifies the air
- Entry-level model with manual controls
- Designed for small and medium sized motorhomes
- Reusable dust filter – easy to remove for cleaning
- Lightweight design helps save fuel
- Input voltage (ac) 220-240 v
- Input frequency 50 hz



## Dometic Freshlight 2200 roof mount air conditioner

**9102900165 : White**

1105 x 210 x 758 mm

- Roof air conditioner,
- Remote control,
- Fixing and installation materials,
- Installation and operating instructions,
- Cooling capacity: 2050 watt,
- Heating capacity: 2700 watt,
- Dimensions:: 1105 x 210 x 758 mm



## Dometic FreshJet FJX4 ADBM air distribution box

**9620000074 : 1500 Manual control**

**9600051008 : 1700/2200 Electric control**

- Optimised airflow for efficiency and reduced noise
- Integrated touch control display
- Integrated lighting – warm white LED's
- Dimensions: 579 X 48 X 418MM
- Vertically adjustable outlet vents for individual airflow regulation
- Cleanair air purifier system
- Reusable dust filter – easy to remove for cleaning
- Net weight 3.90 kg

# Heating & Cooling



## Truma Aventa comfort air conditioner

**44090-51CM : Cream**  
**44090-51GM : Grey**

752 X 225 X 702 mm

- 2400w cooling output and 1700w heating output
- Very efficient in both cooling and heating modes
- Easy to retrofit- can be installed in a place of a 400x400 skylight
- Remote control
- High output despite weighing just 33 kilograms
- Quiet - especially in sleep mode
- Programmable timer
- Led dimmer lighting
- Suitable for vehicles up to 7.5m in length



## Truma Aventa compact and compact plus air conditioners

**44200-01CM : Compact (cream distributor)**  
**44200-01GM : Compact (grey distributor)**  
**44300-01CM : Compact plus (cream distributor)**  
**44300-01GM : Compact plus (grey distributor)**

- Size: 785 x 560 x 265 mm
- Compact : 1700w cooling output , 1200W heating output
- Compact Plus : 2200w cooling output , 1500W heating output
- All with low power consumption
- Suitable for vehicles up to 6m in length
- Can be installed in place of a 400 x 400 skylight
- Convenient adjustment using remote control or app (optional with Truma inet box)
- Includes air distributor



## Truma Aventa comfort second generation air conditioner

**44092-51 : White**  
**44092-52 : Black**

1008 X 665 X 243 mm

- Cooling power: 2500 W
- Heating power: 2000 W
- Cooling mode power consumption (230 V) 4.9 A
- Heating mode power consumption (230 V) 4.2 A
- External unit dimensions: 1008 x 665 x 243 mm (L x W x H)\*
- Dimensions of roof cut-out: 380 x 350 mm/400 x 400 mm (L x W)
- Does not include air distributor (which is purchased separately)
- Total Weight: 28.7 kg (which includes air distributor)



# Heating & Cooling



**Truma Aventa compact plus second generation air conditioner**

**44301-01 : White**  
**44301-02 : Black**

786 X 577 X 245 mm

- Cooling power: 2200 W
- Heating power: 1500 W
- Cooling mode power consumption (230 V) 5 A
- Heating mode power consumption (230 V) 2.1 A
- External unit dimensions: 786 x 577 x 245 mm (L x W x H)
- Dimensions of roof cut-out: 380 x 350 mm/400 x 400 mm (L x W)
- Weight: 24.2 kg (including air distributor)



**Truma Aventa compact second generation air conditioner**

**44201-01 : White**  
**44201-02 : Black**

786 X 577 X 245 mm

- Cooling power: 1700 W
- Heating power: 1200 W
- Cooling mode power consumption (230 V) 3.3 A
- Heating mode power consumption (230 V) 1.55 A
- External unit dimensions: 786 x 577 x 245 mm (L x W x H)
- Dimensions of roof cut-out: 380 x 350 mm/400 x 400 mm (L x W)
- Weight: 23.2 kg (including air distributor)



**Truma Aventa 2<sup>nd</sup> generation standard air distributor**

**40802-01 : Cappauccino**  
**40802-02 : Stone**

- Size: 550 x 497 x 45 mm (L x W x H)
- Weight: 2.7 kg
- For use with second generation models



**Truma Aventa 2<sup>nd</sup> generation premium air distributor**

**40802-06 : Cappauccino**  
**40802-07 : Stone**

- Full adjustable & integrated ambient lighting
- Size: 550 x 497 x 45 mm (L x W x H)
- For use with second generation models



**Truma Aventa Comfort air distributor**

**40801-02 : Grey**

556 x 496 x 46 mm

- 2 Individually adjustable air outlets
- For use with compact / compact plus models



**Aventa comfort diffuser and sealing frame**

**44091-55BLC : Comfort**  
**44091-55BLG : Comfort**  
**44200-02BC : Compact**

**44200-02BG : Compact**  
**44300-03BSC : Compact plus**  
**44300-03BSG : Compact plus**

- BLC : For use with comfort range, colour : black and cream
- BLG : For use with comfort range, colour : black and grey
- 02BC : For use with compact range, colour : black and cream
- 02BG : For use with compact range, colour : black and grey
- 03BSC : For use with compact plus range, colour : black and cream
- 03BSG : For use with compact plus range, colour : black and grey

# Heating & Cooling



**Truma Saphir comfort under bench air conditioner**

**44035-01** 710 x 400 x 290 mm

- For vehicles up to 6.5m long , Lightweight, just 23.5KG
- Practical timer function , 2400w cooling capacity
- In heat pump mode, heats with up to 1700w
- Can be used at camp sites with fuses from six amps
- Consumption during cooling 4.2a , Voltage 230v-240v, 50 hz
- Ducting and vents sold separately
- Control using the app (optional with Truma inet box)



**Truma Saphir compact under bench air conditioner**

**44081-02** 560 x 400 x 290 mm

- For vehicles up to 5.5m long
- Dehumidifies and cleans, there are fluff and particle filters
- Cooling power: 1800w , Timer function
- Can be used at camp sites with fuses from three amps
- Especially light at just 20 kilograms
- Control using the app (optional with Truma inet box)
- Ducting and vent sold separately



**Dometic FreshWell 3000 under bench air conditioner**

**96200173224** 628 x 286 x 400 mm

- Ensures a pleasant, comfortable controlled temperature
- Features a durable, quiet fan with variable speed operation
- Thanks to a modular design and compact dimensions, the installation position can be varied according to vehicle interior and targeted heating.
- Weight: 21 kg



**Truma 65mm cold air ducting (15m Rolls)**

**40200-01**  
Diameter: 65 mm



**Truma air intake circulation grill**

**40040-29200**

- Circulation air intake grill.
- Rectangular, air stream cross section 315 cm<sup>2</sup>

# Refrigeration

# VITRIFRIGO

COOL AND BEYOND



## Vitrifrigo 25L compressor fridge

**VFC25PSIALSX**

442 x 442 x 280 mm

- Featuring a nano compressor for better, more efficient cooling
- Vitrifrigo 25 litre 12 volt (or 24v) DC compressor fridge, shallow depth so popular for small campervan conversions. ideal to run from solar power.
- Popular fridge for VW T4, VW T5, VW T6, Mercedes Vito and Ford Transit conversions.
- Remote compressor
- Standard as left hinge, but can be converted to right hinge
- 12V/240V multi voltage

## VitriFrigo C39i 39L compressor fridge

**VFC39IBLAL : Black**

547 x 390 x 355 mm

**VFC39ISIAL : Grey**

- Featuring a nano compressor for better, more efficient cooling
- Total volume 39 litres
- Freezer volume 3.6 litres
- Net weight 17kg
- Power supply 12/24V DC
- Nominal consumption 31w
- Reversible door



## VitriFrigo C42L 42L compressor fridge Grey

**VFC42LGRCL**

532 x 380 x 342 mm

- Featuring a nano compressor for better, more efficient cooling
- Weight 16 kg
- Front loading fridge/freezer
- Refrigeration colour: grey
- Refrigeration input voltage: 12/24 v, multi-voltage
- Remote compressor



## VitriFrigo 50L compressor fridge Black

**VFC50IBLBDN**

532 x 380 x 459 mm

- Featuring a nano compressor for better, more efficient cooling
- Standard left hinge, convertible to right hinge
- Automatically runs on 12V or 24V, with low voltage cut out and high voltage protection
- Thermostatic temperature control
- Internal LED light
- Highly efficient nano compressor for better energy usage and chilling performance

# Refrigeration

## VitriFrigo C50l 50L compressor fridge Grey

**VFC50IGRBDN** 532 x 380 x 459 mm

- Featuring a nano compressor for better, more efficient cooling
- Interchangeable decor panel on doors to match furniture
- Standard left hinge, convertible to right hinge
- Efficient Secop compressor with aluminium finned condenser
- Automatically runs on 12V or 24V, with low voltage cut out and high voltage protection
- Positive catch with vent position for airing when not in use
- Supplied standard with one-star (-6°C) ice box for making ice cubes and storing food for three to four days



## Vitrifrigo 51L compressor fridge Grey

**VFC51IGRBDN** 532 x 380 x 459 mm

- Featuring a nano compressor for better, more efficient cooling
- 1mm replaceable front decor panel and positive closure with vitrifrigo's 'air lock' latch with vent position
- Automatically runs on 12V or 24V
- Upgradeable to run on 12/24V and 110/240V AC 50/60 HZ
- 3.6L ice box, Door can be hinged left or right, Internal led light
- Tough food safe injection moulded liner with internal wire shelf with fiddle up stand



## VitriFrigo 60L compressor fridge

**VFC60IBLCL : Black**

622 x 470 x 415 mm

**VFC60PBLAL : Larder air lock**

**VFC60IGRCL : Grey**

- Featuring a nano compressor for better, more efficient cooling
- Integral compressor mounted at the base of the cabinet
- Shallow depth fridge
- Can be supplied without ice box
- 15.8kg, 12/24V

## Vitrifrigo 85L compressor fridge Grey

**VF85IGRCL** 791 x 485 x 427 mm

- The Chromelock series is the new complete range that covers every requirement in terms of space and capacity. Ergonomic, quiet, intuitive and safe, it is able to guarantee maximum on-board comfort.
- Featuring a nano compressor for better, more efficient cooling
- Weight: 25 kg, Volume : 85L, Freezer volume: 12.8 L
- Voltage options: 12/24V DC (upgradeable to 12/24 & 110-240V AC)
- Consumption in Watts (with compressor running): 40W
- Average 12 Volt Consumption (over 24 hours in UK summertime): 1.2 A/h



## Vitrifrigo 85L compressor fridge Black

**VFC85IBLBDN**

532 x 380 x 459 mm

- The Chromelock series is the new complete range that covers every requirement in terms of space and capacity. Ergonomic, quiet, intuitive and safe, it is able to guarantee maximum on-board comfort.
- Ergonomic, quiet, intuitive and safe
- Featuring a nano compressor for better, more efficient cooling
- Optional extra VFR121138.K fitting frame
- Total volume : 85L, Freezer volume : 12.8L
- Net weight : 23.3 kg

# Refrigeration

## Vitrifrigo 90L compressor fridge Grey

**VFC90IGRCL**

622 x 470 x 515 mm

- The Chromelock series is the new complete range that covers every requirement in terms of space and capacity. Ergonomic, quiet, intuitive and safe, it is able to guarantee maximum on-board comfort.
- Featuring a nano compressor for better, more efficient cooling
- Total volume: 90L , Freezer volume 9,1 L , Net weight : 22 kg
- Power supply: dual electronic box 12/24V DC - 100-240V AC 50/60Hz
- Nominal consumption: 45W
- Panel colour: black
- Reversible door: yes



## Vitrifrigo 90L compressor fridge Black

**VFC90IBLCLMV**

622 x 470 x 515 mm

- The Chromelock series is the new complete range that covers every requirement in terms of space and capacity. Ergonomic, quiet, intuitive and safe, it is able to guarantee maximum on-board comfort.
- Featuring a nano compressor for better, more efficient cooling
- Total volume: 90L , Freezer volume 9,1 L , Net weight : 22 kg
- Power supply: dual electronic box 12/24V DC - 100-240V AC 50/60Hz
- Nominal consumption: 45W , Panel colour: black , Reversible door: yes

## Vitrifrigo 95L compressor fridge Grey

**VFC95LSIAL**

712 x 485 x 429 mm

- The Airlock C95L fridge-freezer is an optimal solution, boasting a total capacity of 95L, with 12.8L allocated to the freezer compartment if chosen as an option. The refrigerant unit is positioned externally. Among its key features, you'll find a grey panel door with a snap-lock mechanism designed to prevent accidental openings.
- Featuring a nano compressor for better, more efficient cooling
- Door Finish : Laminate
- Capacity : 95 L , Voltage : 12/24V DC , Remote compressor



## Vitrifrigo C115I 115L compressor fridge Silver

**VFC115iSIAL**

766 x 525 x 518 mm

- 115 litre 12/24 volt fridge with integral compressor, 27.4kg 12v/24v
- Featuring a nano compressor for better, more efficient cooling
- With ice box
- Optional fitting frame, Door can be hinged left or right, Internal led light
- Compressor voltage: automatically runs on 12v or 24v
- Can be integrated and fitted behind galley cupboard doors using sliding hinge kit (VFR12468)

## Vitrifrigo C115I 115L compressor fridge Black

**VFC115IBLALSX-LED**

766 x 525 x 560 mm

- The C115i fridge-freezer from the Airlock series offers an ideal solution with a total capacity of 115L, including 17.1 L for the freezer compartment, if selected as an option. The refrigeration unit is positioned internally.
- Featuring a nano compressor for better, more efficient cooling
- This appliance features a black panel door with a secure snap-lock closure to prevent accidental openings.
- Internal LED



# Refrigeration



## Vitrifrigo Slim150 compressor fridge freezer Black

**VFDP144LBLALGR**

- 9L 3 star freezer compartment
- Supplied pre-charged with couplings
- Remote compressor
- Stainless steel drawers & runners
- Drawer is 365mm making it ideal for storage of large drinks bottles
- Doors can be hung left or right
- LED digital thermostat
- Turbo mode or fast chill boost
- Automatically runs on 12v or 24v
- Positive closure with Vitrifrigo's 'air lock' latch with vent position



## Vitrifrigo 20L top loading compressor fridge Black

**VFTL20L-R600a**

325 x 248 x 426 mm

- Vitrifrigo narrow width, top opening 12/24 volt fridge ideal for shallow depth work surfaces. perfect for small conversions.
- Refrigeration application : Leisure, marine, off-grid
- Refrigeration type : Fridge
- Refrigeration colour :Black
- Refrigeration fridge type : Top loading
- Refrigeration input voltage : 12/24V, multi-voltage



## Vitrifrigo DP150 150L compressor fridge freezer Black

**VFDP150IBLCL**

1095 x 525 x 530 mm

- Automatically runs on 12v or 24v, by sensing the input voltage
- Supplied with the positive air lock latch system with vent position
- 1mm front panel which can be changed to match kitchen units
- Internal led light as standard
- Internal grill shelves with fiddle upstands and salad bins as standard
- Weight: 38.8kg
- Freezer:30L



## VitriFrigo compressor drawer fridge Black

**VFD20ABL : 20L**

285 x 440 x 727 mm

**VFD30ABL : 30L**

- Compact drawer fridge freezer
- Automatically runs on 12v or 24v
- The compressor and cooling unit can be removed from the back of the drawer and mounted remotely up to 1.5m from the drawer
- LED thermostat control
- The drawer cannot open when driving over rough terrain or cornering in a vehicle or motorhome

## Vitrifrigo 40L top loading compressor fridge or freezer

**VFTL43L**

620 x 500 x 340 mm

- Membrane LED Digital thermostat
- Lowest noise level and reduced consumption during night time
- High bright internal Led lights
- Inside out fixings and concealed lid fixings for easy installation
- Removable seal and easy replacement
- The external compressor is removable up to 1,5m
- 12/24V DC 100-240V AC - 50/60 Hz, Nominal Consumption 45w
- Total Volume 40L
- Net Weight 14.5kg
- Internal Temperature Range +10°C / -10°C



# Refrigeration



**Dometic RC10.4T compressor fridge  
Black**

**9600050782 : 70L**

821 x 420 x 450 mm

**9600050783 : 90L**

975 x 420 x 485 mm

- Double-hinged door
- Patented removable freezer compartment
- Ease of use with TFT colour display and turn/push button
- Reliable cooling and deep-freezing
- Elegant aluminium door handles
- Internal ventilation system – no further ventilation grills required
- Quiet operation in night mode
- 12/24v



**Dometic RCD 10.5T 176L compressor fridge  
Black**

**9600050528**

1283 x 523 x 550 mm

- Double-hinged doors – open left and right without the need to change the hinge, Separate doors for the fridge and freezer
- VG Fresh crisper with adjustable humidity – keeps fruit and vegetables fresh for longer
- Elegant aluminium door handles extend over the complete fridge height
- Internal ventilation system – no further grills required for installation
- Easy to use controls with intuitive TFT colour display



**Dometic RCS10-5XT 98L compressor fridge  
Black**

**9600028199**

821 x 610 x 523 mm

- Extra deep & TFT display
- Double-hinged door – opens left and right without the need to change the hinge
- Patented removable freezer compartment (opens to the bottom)
- Smart use of space: extra-deep under counter model with wheel arch cut-out

# Refrigeration



**Dometic NRXC compressor fridges - Dark Silver**

**9620001484 : NRX35C : 35L** 525 x 380 x 480 mm  
**9620001481 : NRX50C : 50L** 525 x 380 x 510 mm  
**9620001486 : NRX60C : 60L** 525 x 448 x 537 mm

- 12/24 V DC , Touch control panel , Integrated LED light bar
- **NRX35C** : 34L Total capacity, 4.4L Freezer capacity
- **NRX50C** : 46L Total capacity, 4.4L freezer capacity
- **NRX60C** : 58L Total capacity, 6.1L freezer capacity



**Dometic NRX50E 50L compressor fridge Black**

**9620000804 : NRX50E : Black** 525 x 380 x 510 mm

- 46L capacity
- Frame less door
- Full-width handle



**Dometic NRX80C 80L compressor fridge Dark Silver**

**9620001483** 625 x 475 x 537 mm

- Total Volume : 78 L
- Fridge : 72 L
- Freezer : 6.1 L (Removable)
- Full-width handle
- Touch control panel
- Integrated LED light bar

**Dometic NRX90 90L compressor fridge Dark Silver**

**9620006673** 821 x 486 x 480 mm

- Net weight : 22 kg
- Total volume : 92 L
- Fridge Total : 70.6 L
- Freezer Volume : 8.4 L
- Input voltage (DC), [V] 12/24
- Integrated LED light bar



**Dometic NRX115C 115L compressor fridge Dark Silver**

**9620001485** 525 x 745 x 568 mm

- 116L capacity
- Full-width handle
- 9L freezer
- Touch control panel
- Integrated LED light bar

**Dometic NRX130C 130L compressor fridge Dark Silver**

**9620001482** 812 x 525 x 568 mm

- 126L of cool storage
- Full-width handle
- Removable 8.2L freezer



# Refrigeration



**Dometic RMS10.5T 83L absorption fridge freezer Black**

**9600027101**

821 x 523 x 548 mm

- Double-hinged door
- Removable freezer compartment
- Smart use of space: under counter model with wheel arch cut-out
- Easy to use with TFT colour display and turn/push button
- Noiseless absorption cooling
- Net weight: 27.4 kg
- Gross volume 83L
- Storage volume - total 81L
- Fridge storage volume 67.8 L
- Freezer storage volume 8.2 L



**Dometic RM10.5T 93L absorption fridge Black**

**9600027098**

821 x 523 x 548 mm

- Double-hinged door
- Patented removable freezer compartment
- Ease of use with TFT colour display and turn/push button
- Elegant aluminium door handles
- Flexible interior storage with two small crisper's
- Noiseless absorption cooling on 12 v, 230 v or petrol
- Full side led interior light
- Net weight 28 kg



**Dometic RML10.4T 139L absorption fridge - black**

**9620004548**

1293 x 420 x 578 mm

- Patented double-hinged door
- Removable freezer compartment
- Elegant aluminium door handles
- TFT display and turn/push button
- VG Fresh crisper with adjustable humidity
- 170W , Voltage : 12V (DC) , 230V (AC)



**Dometic RMD 10.5T 153L absorption fridge - black**

**9620006713**

1245 x 523 x 550 mm

- Patented double-hinged door
- TFT display and turn/push button
- 3 Way : Electric (240V or 12V) or gas
- Two-point locking system
- Versatile interior , LED light bar , Crisper
- Gas consumption : 580g/24h



**Dometic RM10.5XT 177L absorption fridge - black**

**9620012756**

1245 x 523 x 605 mm

- Patented double-hinged door
- TFT display and turn/push button
- 3 Way : Electric (240V or 12V) or gas
- Two-point locking system
- Versatile interior , LED light bar , Crisper
- Gas consumption : 580g/24h

# Refrigeration

# THETFORD



**Thetford T2090 84L  
compressor fridge - black**

**692932SP** 975 x 418 x 486 mm  
**692931 (OEM)**

- OEM Model (692931) has no front panel
- LCD control panel
- Door shape: flat , hinged: Right
- Energy: 0.35 kW/24h, Net weight: 34.2kg,
- Total volume: 84L , Freezer volume: 6.1L



**Thetford T2095 90L  
compressor fridge - black**

**693463SP** 975 x 418 x 486 mm

- LCD control panel
- Door shape: flat framed , slide out
- Energy: 0.36 kW/24h
- Net weight: 33kg,
- Total volume: 90L
- Freezer volume: 9 L



**Thetford T2138 138L  
compressor fridge - black**

**692935SP** 1598 x 418 x 503 mm

- Slim line fridge
- LCD control panel
- Door shape: flat , hinged: Right
- Energy: 0.50 kWh/24h
- Net weight: 34.2kg
- Total volume: 138L , Freezer volume: 13.6L



**Thetford T2152 150L  
compressor fridge - black**

**692937SP** 1500 x 418 x 569 mm

- Slim line fridge : LCD control panel
- Door shape: flat , hinged right
- Energy consumption: 0.47kwh/24h
- Net weight: 35kg
- Total volume: 150L, Freezer volume: 17L



**Thetford T2160 158L  
compressor fridge - black**

**692943SP** 1245 x 525 x 563 mm

- LCD control panel
- Door shape: flat , hinged right
- Energy consumption: 0.56 kWh/24h
- Net weight: 37.4kg
- Total volume: 158L, Freezer volume: 30.5L



**Thetford T2175 174L  
compressor fridge - black**

**692946SP** 1245 x 525 x 613 mm

- LCD control panel
- Door shape: flat , hinged right
- Energy consumption: 0.56 kWh/24h
- Net weight: 38.4 kg
- Total volume: 174L, Freezer volume: 35L

# Refrigeration



**Thetford N4080E / N4080E+ absorption fridge Black**

**692054SP : N4080E+**  
**692056SP : N4080E**

821 x 486 x 543 mm

- Control panel: led
- Door shape: flat framed 30mm
- Door type hinging: left
- Energy: 2.6 kwh/24h , 270g/24h
- Energy selection: manual
- Single pressure absorption
- Net weight: 22.5kg
- Gross Volume: 81L
- Total Volume : 71 L
- Freezer Volume : 10 L



**Thetford N4090E+ absorption fridge Black**

**692180 : OEM packed**  
**692056SP : Retail packed**

821 x 525 x 543 mm

- Control panel: led
- Door shape: flat framed 30mm
- Door type hinging: left
- Energy: 2.9 kwh/24h , 300g/24h
- Energy selection: manual
- Single pressure absorption
- Net weight: 22.5kg
- Gross Volume: 89L
- Total Volume : 78 L
- Freezer Volume : 11 L



**Thetford N4141 141L absorption fridge Black**

**692168 : A**

**692087SP : E+**

1500 x 418 x 561 mm

- Slim line fridge
- A Model has LCD control panel
- E+ model has LED control panel
- Door shape: flat , hinged left
- Energy: 4.5 kWh/24h , 468 g/24h
- Net weight: 38kg
- Total volume: 135L, Freezer volume: 15L



**Thetford N4142 142L absorption fridge Black**

**692134SP A**

**692095SP E+**

1500 x 418 x 561 mm

- Slim line fridge
- A Model has LCD control panel
- E+ model has LED control panel
- Door shape: flat , hinged left
- Energy: 4.5 kWh/24h , 468 g/24h
- Net weight: 37kg
- Gross volume: 142L
- Total volume: 135L, Freezer volume: 15L

# Refrigeration



## Thetford N4145E 136L absorption fridge Black

**692102SP**

1245 x 525 x 543 mm

- Door shape: flat framed 10mm
- Energy selection: manual
- Net weight: 37kg
- Total volume: 136L
- Freezer volume: 23L
- Door type hinging: left
- Control panel: LED

## Thetford N4150A 149L absorption fridge Black

**692105SP**

1245 x 525 x 578 mm

- Left hand framed door
- Power supply, gas, 12v and 230v
- Stable and strong 3-way cooling
- LCD control panel
- Automatic and manual energy source selection
- Gross volume 149L
- Freezer volume 25L

## Thetford N4175A 175L LCD absorption fridge Black

**692118SP**

1245 x 525 x 628 mm

- Door shape: curved framed
- Energy selection: automatic
- Control panel: LCD
- Net weight: 39.5kg
- Total volume: 165L
- Freezer volume: 31L
- Door type hinging: left

## Thetford N4175A absorption fridge Black

**692119SP**

1245 x 525 x 628 mm

- Door shape: curved frame less
- Energy selection: automatic
- Control panel LCD
- Doors can be converted to right doors with the door swing kit (is included)
- Net weight 39.5 kg
- Total volume 165L
- Freezer volume: 31L
- Refrigerant amount 126 g

## Thetford N4175E absorption fridge Black (retail packed)

**692122SP**

1245 x 525 x 628 mm

- Door shape: curved framed
- Control panel: LED
- Door type hinging: left
- Energy consumption: 4.0kwh/24h
- Energy consumption (gas): 420g/24h
- Single pressure absorption refrigerator
- Frozen compartment: 31L
- Total volume: 165L
- Energy selection: automatic
- Net weight: 39.5kg

## Thetford N4170E+ absorption fridge Black

**692117SP**

1245 x 525 x 593 mm

- Double-door
- Total volume: 156 L
- Freezer volume: 29 L
- Power supply, gas, 12v and 230v (between 210 and 250v)

## Thetford N4170A absorption fridge Black

**692112SP**

1245 x 525 x 593 mm

- LCD control panel
- Matte black door panel
- Door shape flat framed
- Door type hinging left
- 156L fridge
- 29L freezer
- 3 way power supply, gas, 12v, 240v

## Thetford Fridge N4150-A absorption fridge Black

**692106SP**

1245 x 525 x 578 mm

- Curved frame less door
- Control panel: LCD
- Door type hinging: left
- Energy consumption: 4.0kwh/24h
- Energy consumption (gas): 420g/24h
- Energy selection: automatic
- Refrigeration technology: single pressure absorption refrigerator
- Total volume: 145L
- Frozen compartment: 25L
- Net weight: 37.5kg

## Thetford N4150E absorption fridge Black

**692107SP**

1245 x 525 x 578 mm

- Door shape: curved framed
- Door type hinging: left
- Energy consumption: 4.0 kwh/24h
- Weight: 37.5kg
- Total volume: 149L
- Double doored
- Control panel with LED display

# Refrigeration



Thetford fridge ventilator kit

**630543**

- Original Thetford part.
- Improves the airflow over the condenser, temperature control and maximisation of the total cooling capacity



Vitrifrigo fitting frame for 39 litre fridge air lock - silver

**VFR121120.GK**

- Original Vitrifrigo part.
- Fitting frame for Vitrifrigo 39 litre air lock fridge
- Silver in colour



HEATEK CF1 fridge fan

**3304001**

- Fits all absorption refrigerators , Integrated mounting and on/off switch
- High performance cooling , Low noise and low power consumption
- Operating voltage: 12V DC, Power consumption: 1.8 W
- Airflow: 70 m /h , Noise level: 22 dB(A)
- Dustproof and waterproof: IP 45 ,Power cable: 150 cm



N3141 / N4141 cabinet infill panel – Piano black

**690630138SP**

394 x 947 x 1.5 mm

- Original Thetford part.
- Cabinet infill for the Thetford N3141 and N4141 fridge models



N3141 / N4141 drawer infill panel – Piano black

**690631138**

394 x 450 x 1.5 mm

- Original Thetford part.
- Drawer infill for the Thetford N3141 and N4141 fridge models



Thetford T2090 door panel  
Matt black

**69233027SP**

- Original Thetford part.
- T2090 door panel insert
- Single pack

# Refrigeration



## Thetford table top fridge vent covers and frames

**62445480 : White full vent**  
**62445427 : Black full vent**  
**62445425 : Dark grey full vent**  
**62844880 : White OEM grill only**  
**62844825 : Dark grey OEM grill only**  
**62407780 : White OEM frame only**

- Original Thetford part
- Compatible with Thetford tabletop fridges
- Vent size : 186 x 483 mm
- Cut out size : 154 x 449 mm
- NET Ventilation area : 363 cm<sup>2</sup>
- Weight: 0.5 kg

## Thetford slim fridge vent covers and frames

**69110080 : White full vent**  
**69110027 : Black full vent**  
**69110025 : Dark grey full vent**  
**69078980 : White OEM grill only**  
**69078927 : Black OEM grill only**  
**69078925 : Dark grey OEM grill only**  
**69079080 : White OEM frame only**  
**69079027 : Black OEM frame only**

- Original Thetford part
- Compatible with Thetford fridges 418 mm wide
- Vent size : 257 x 432 mm
- Cut out size : 228 x 400 mm
- NET Ventilation area : 467 cm<sup>2</sup>
- Weight: 0.6kg



## Thetford large fridge vent covers and frames

**63114080 : White full vent**  
**63114027 : Black full vent**  
**63114025 : Dark grey full vent**  
**63114180 : White OEM grill only**  
**63114125 : Dark grey OEM grill only**  
**63114280 : White OEM frame only**

- Original Thetford part
- Compatible with Thetford large fridges
- Vent size : 281 x 523 mm
- Cut out size : 249 x 489 mm
- NET Ventilation area : 643 cm<sup>2</sup>
- Weight: 0.7 kg



# Refrigeration



Thetford small winter covers

**62445580 : White**  
**62445527 : Black**

**62445525 : Dark Grey**

- Original Thetford part, compatible with Thetford tabletop fridges
- Cover size : 186 x 483 mm , Cut out size : 130 x 437 mm
- Weight: 0.206 kg

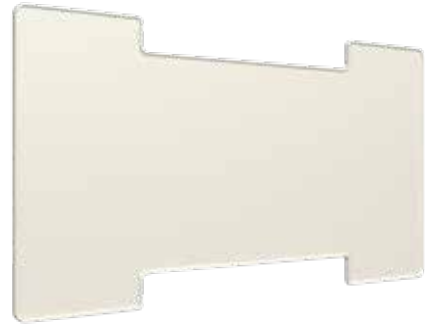

Thetford large winter covers  
Multiple sizes available

**69109980 : White : Slim fridges**  
**63115080 : White : Large fridges**

- Original Thetford part, compatible with Thetford slim and large fridges
- Slim : Size : 257 x 432 mm , Cut out : 210 x 390 mm, Weight: 0.714 kg
- Large : Size : 281 x 523 mm , Cut out : 234 x 482 mm, Weight: 0.714 kg



Dometic LS100 fridge top vent

**9620009231 : White**

**9620009243 : Black**

- Original Dometic part
- Size : 45 x 479 x 185 mm (D x W x H)
- Includes winter cover



Dometic LS200 fridge bottom vent

**9620009291 : White**  
**9620009217 : Black**

- Original Dometic part
- Size: 45 x 479 x 185 mm (D x W x D)
- Weight 0.48 kg



Dometic fridge winter cover kit  
Includes WA120 and WA130

**9620009215 : White**  
**9500001460 : Black**

- Original Dometic part
- WA120 covers top vent (LS100) and WA130 covers bottom vent (LS200)



Dometic LS300 fridge double door grill vent

**9620009255 : White**

- Original Dometic part
- Size : 518 x 278 mm (W x H)
- Suggested cut out 490 x 249 mm



Dometic EWS300 fridge winter cover

**9105900017 : White**

- Original Dometic part
- Winter cover kit for LS300 vents
- Size: 515 x 275 x 30 mm (H x W x D)

# Cookware



## Dometic MO9722 Slimline Piezo Hob and Sink Unit

**MO9722LP : Left hand**

**MO9722RP : Right hand**

**9620017483 : Left hand with gas shut off**

**9620017484 : Right hand with gas shut off**

- Size: 760 x 179 x 325 mm
- Heat resistant glass lids
- Enamel LED burner caps
- Recessed controls
- 20mm waste outlet.
- Cut-out: 742 x 283 mm
- Sink: 270 x 220 x 130 mm
- Weight : 6 kg
- Burners : 1.8 kw, 1.0 kw
- Models : 9620017483 and 9620017484 have glass lid - gas shut off feature

**LEFT HAND  
PART  
PICTURED**

## Dometic SMEV MO9222 2 Burner Hob and sink combi unit

**MO9222L : Left hand**

**MO9222R : Right hand**

**9620017487 : Left hand with gas shut off**

**9620017488 : Right hand with gas shut off**

- Size : 152 x 900 x 370 mm
- Heat resistant glass lids
- Detachable chromed grids
- Enamelled burner caps
- Recessed controls
- Safety ignition system
- Gas consumption (g/h) : 2.8
- Gas pressure (mbar) : 30
- Models 960017487 and 9620017488 have glass lid - gas shut off feature



**RIGHT HAND  
PART  
PICTURED**



## Dometic Vision Double Burner CVH1525G with gas shut off

**9600050573**

525 x 97 x 350 mm

- Twin burner gas hob
- Soft close lid
- Safety glass
- Heat resistant
- Gas shut off
- EN30-1-1 compliant
- Power : 1 x 1.1 kW; 1 x 2.0 kW
- Gas consumption 146 g/h
- Gas connection 30 mbar
- Weight 5 kg



## Dometic Vision Combination Unit CVC1700G sink gas shut Off

**9600051209 : Left hand**

**9600051167 : Right hand**

700 x 170 x 350 mm

- Available in left or right handed versions, both with gas shut off
- Heat-resistant
- Safety glass-lid
- New burner
- Soft-close hinges
- Gas-cut-off
- EN30-1-1:2021 compliant
- Weight: 7.9 kg
- Output 1 x 1.1 kW; 1 x 2.0 kW

**LEFT HAND  
PART  
PICTURED**



# Cookware



Thetford Induction Hob

**SHB90288-SP**

53 x 305 x 500 mm

- Weight: 5.5 kg
- Touch controls
- Induction zones: 1.4 Kw (1.8 Kw Boost) / 1.8 Kw (2.3 Kw Boost)



Dometic CVI1525 Vision 2 Zone Induction Hob

**9600050571**

350 x 55 x 525 mm

- 2-zone hob with state-of-the-art induction technology
- Convenient regulation of the cooking heat in 9 steps
- Retains its beauty for a long time
- Vibration resistance
- Designed to respect 10A /2300 W limitations
- For extra-fast heat-up with automatic over-boost cut-off



Thetford TOPLINE 922 2 burner Hob

**SHB92298-SP**

500 x 305 x 95 mm

- Strong ceramic glass
- Frame less glass for easy cleaning
- 12V all gas cooker

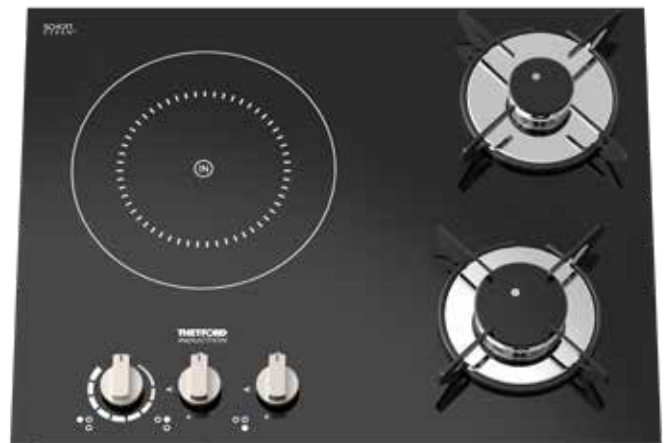

Thetford TOPLINE 981 Hybrid Hob 2x Gas and 1x Induction

**SHB98199-SP**

100 x 500 x 380 mm

- Gas Burners - 1x1.0KW, 1x1.5KW
- Induction - 145MM 1.4KW
- Ignition -12V Spark Ignition
- Lid - Gas lid shut-off - 6.5KG
- Weight - 6.5kg
- Hob capacities (mm) : - 100 - 160, 120 - 200, 180 - 220

# Cookware



Thetford TOPLINE 931 3 Burner Hob

**SHB93199-SP**

95 x 770 x 350 mm

- Hob material: glass
- Fixation: surface mounted
- Total heat input (kw): 5.0kw
- Burners: 1.5kw, 1.0kw, 2.5kw
- Ignition: 12v
- Weight: 6.0kg



Thetford TOPLINE 910 1 burner Hob

**SHB91099-SP**

95 x 305 x 355 mm

- Fixation: invisible foam seal
- Fuel: all gas
- Burners: 1.5 kw
- Hob material: black glass
- Net weight: 4.0 kg
- Total heat input (gas): 1.5 kw
- Cut-out (wxd): 285 x 335 mm
- Knobs: matt nickel straight



Thetford TOPLINE hob 165 Long side

**SHB16549-SP**

106 x 576 x 361 mm

- Total heat input (gas) : 4kw
- Gas burners : 1.5kw / 2.5 kw
- Ignition : 12v
- Hob material : black glass
- Knobs : matt nickel straight
- Glass lid : yes (black)
- Fixation : surface mounted
- Net weight : 8kg
- Side hinge



Thetford TOPLINE 111 2 Burner Hob and sink combination unit

**SCU11189-SP**

195 x 900 x 370 mm

- Surface mounted fixation
- All gas fuel
- Gas burners: 2 x 1.5kw
- Glass lid
- Hob material: black glass
- Ignition: 12v
- Knobs: matt nickel straight
- Net weight: 11.0kg
- Total heat input: 3.0kw

# Cookware



Thetford Triplex 3 Burner Hob & Oven

**SOH70997-SP**

468 x 463 x 500 mm

- Oven capacity: 36 litres
- Burners: 2 x 1.8kw and 1 x 2.4 kw
- Oven: 1.6kw, Grill: 1.6kw
- Ignition: 12v
- With lid shut off
- Built-in dimensions: 463 x 445 x 493 mm



Thetford K1520 4 All Gas cooker 12V IGN

**SCK41199-SP**

645 x 515 x 501mm

- High-quality materials and components
- Contemporary, home-like design
- Optimal use of space
- Superior cooking performance
- Knobs: Brushed nickel
- Net weight: 25 Kg



Thetford Midi Prima 3 Without Lower Pan Storage

**SOP70998-SP**

458 x 640 x 450 mm

- Overall : 644 x 444 x 450 mm
- Built-in : 646 x 445 x 490 mm
- Total heat input (gas) : 3.1Kw
- Fuel : all gas
- Gas burner : 1.5Kw
- Oven burner : 1.6Kw
- Ignition : 12v
- Oven capacity : 36L
- Grill capacity : 13L
- Knobs : matt nickel straight
- Net weight : 18Kg



Thetford Dual Fuel 12V Ignition cooker

**SCK42199-SP**

645 x 515 x 501 mm

- Electric hotplate 1025 w
- Features grill pan kit / • 2 oven shelves
- Fuel dual fuel
- Gas burners 1 x .95 kw / 2 x 1.72 kw
- Grill burner 1.64 kw
- Grill capacity 15L
- Ignition 12v dc
- Knobs brushed nickel
- Net weight 25.5 kg
- Oven capacity 34 l
- Total heat input (electric) 1.0 kw
- Total heat input (gas) 8.0 kw

# Cookware



Thetford 420 Oven

**SOV4205-SP** 418 x 335 x 440 mm

- Oven capacity: 23 litres
- Total heat input: 1kw
- Spark ignition (12v DC)
- Weighs 10.5kg
- Accessories: oven shelf x 2
- Options: oven light
- Retail packed
- Size: 418 x 335 x 440 mm



Thetford 525 Oven

**SOG5205-SP** 369 x 525 x 480 mm

- Total heat input : 2.5 KW
- Grill Burner : 1.5 KW
- Oven Burner : 1 KW
- Ignition : 12V
- Oven Capacity : 23L
- Knobs : Chrome & black cylinder
- Net weight : 15.8kg



Thetford Duplex XL Oven and Grill

**SOG10975** 518 x 496 x 483 mm

- The duplex is a high quality combined oven and grill, with easy to clean stainless steel interior.
- 12V Ignition
- Fan: 12V DC / 150mA / 1.8W
- Oven Capacity: 50L
- Weight: 20kg
- Butane (G30): 28 - 30 mbar
- Propane (G31) : 37 mbar



Thetford Duplex Oven

**SOG70998-SP** 445 x 456 x 490 mm

- Build-in: 438 x 445 x 490mm
- Gas burner: 1.6kw
- Grill burner 1.6kw
- Ignition: 12v
- Net weight: 14.0kg
- Oven capacity: 36l
- Total heat input: 3.2kw
- Knobs: matt nickel straight



Dometic OV 1800

**9103303708** 410 x 311 x 490 mm

- 12V DC (electric ignition)
- Output: 1.1kw
- Gas consumption: 80g/h
- Gas supply pressure: 30mbar
- Oven capacity: 18 litres
- Weight: 13.7kg
- Built-in size: 398 x 304 x 490 mm
- Electronic 12-volt ignition
- Heat-resistant and
- Panoramic glass door



Dometic OG3000

**9103303709** 530 x 430 x 415 mm

- Stainless steel oven with grill
- Stainless steel grid & baking
- Interior light
- Electronic 12v ignition with safety ignition system
- Thermostat
- Easy clean door and interior
- Chimney connection

# Cookware



**Russell Hobbs Microwave**

**RHM2063AH** 500 x 400 x 320 mm

- Suitable for caravans
- 800 watt
- 20L capacity
- 5 power settings



**Dometic MWO 240 Microwave Oven**

**9600028283** 353 x 283 x 451 mm

- Five cooking levels & defrosting function
- Easy-to-clean ceramic plate
- LED display and cooking end signal
- 10.8 kg , 230v



**Dometic CK155 Ventilator**

**9107300315** 399 x 71 x 277 mm

- Compact fan is integrated into the roof dome and not into the unit itself
- Quickly draws cooking fumes, odours and moisture out of the cabin
- Two fan speeds equipped with 12V motor



**Dometic CK500 Extractor**

**9106506287** 530 x 60 x 204 mm

- Elegant and easy to clean control panel of heat resistant glass, plus timer based operation
- Set the fan speed, clock time and lighting
- Hygienic stainless steel surfaces and the 5-layer metal grease filter are easy to clean



**Sterling Twin Induction Hob**

**IHFB** 495 X 265 mm

- 230v (ac) | 50hz | 2800w
- Front 1200w max , Rear 1800w max
- Zinc alloy plated bottom
- A-grade black crystal plate
- Coil heating and Auto shut off



**Sterling Induction Hob Fixed Twin Side by Side**

**IHSBS** 365 x 575 mm

- 230v (ac) | 50hz | 2800w
- Left 1800w max , Right 1800w max
- Zinc alloy plated bottom
- A-grade black crystal plate
- Auto shut off



**Sterling Induction Portable Hob**

**IHP** 282 x 311 x72 mm

- 230v (ac) | 50hz | 1500w
- 8 settings 200w-1500w
- A-grade black crystal plate
- Double layered coil heating
- Housing material: pp+abs.



**Sterling Induction Single Hob 1800W**

**IH1** 288 x 82 mm

- 1800W Induction hob
- Intelligent cooking functions | Power light
- Over heat + voltage + current protection
- Auto shut off in1 minute without induction pan
- 1.5m cable & British standard plug



**Sterling Induction Single Hob 1000W Max Lite**

**IH1L** 195 x 82 mm

- 1000W induction hob
- Intelligent cooking functions | Power light
- Over heat + voltage + current protection
- Auto shut off in1 minute without induction pan
- 1.5m cable & British standard plug

# Water



Truma 14L electric water heater

**71201-20**

- Power supply: 230v 50hz.
- Power consumption: 3.7a (850w)
- Water capacity: 14 litres
- Water fittings not included
- Approx. 70 mins 15°C-70°C
- Over-temp. protection: 90°C
- Control panel
- 3m cable
- Electric heating element



Truma Therme TT2 5L electric water heater

**42014-01**

370 x 220 x 230 mm

- 300w power consumption
- Weight: 2kg
- Power supply: 230v - 50hz
- Water capacity: 5 litre
- Operating pressure: max 1.2 bar
- Temperature limit: 65c



## Heatek boilers

**3408332 : 3L XB-3 Combi Boiler**

250 x 190 x 190 mm

- The 3L comes as a combi with a 12V DC 200W heating element and a 230V AC 300W heating element.
- 3L stainless steel tank
- Insulating EPP housing
- Temperature limit: 70°C
- Over temperature protection
- Pump pressure: max. 3.5 bar
- System pressure: max. 4.5 bar
- For pressure-resistant hot water hoses with 10 mm diameter
- Complies with European drinking water standard 98/83/EC
- Heat up time: 230V AC 38min / 12V DC 57min

**3408361 : 6L XB-6 Boiler**

300 x 223 x 223 mm

- The 6L comes with a 230V AC 300W heating element
- Water capacity: 6 L
- Tank material: stainless steel
- Insulating EPP housing
- Temperature limit: 70°C
- Over temperature protection: 75°C
- Pump pressure: max. 3.5 bar
- System pressure: max. 4.5 bar
- For pressure-resistant hot water hoses with 10 mm diameter
- Complies with European drinking water standard 98/83/EC
- Heat up time 230V AC: 76min

**3408311 : 10L XB-10 Boiler**

319 x 270 x 270 mm

- 10L with a 230V AC 600W element.
- Water capacity: 10 L
- Tank material: stainless steel
- Insulating EPP housing
- Temperature limit: 70°C
- Over temperature protection: 75°C
- Pump pressure: max. 3.5 bar
- System pressure: max. 4.5 bar
- For pressure-resistant hot water hoses with 10 mm diameter
- Complies with European drinking water standard 98/83/EC
- Heat up time: 230V AC 63min

# Water



## Truma Ultrastore Rapide GE boiler

**73611-01PK: Standard fitting**  
**73611-02PK : JG fittings**

350 x 350 x 320 mm

- Liquid gas (propane/butane)
- 10 litres
- Heating time 16 mins
- Weight - 7,4 kg
- Gas consumption- 120 g/h
- Power consumption (12V) - 0.16 a, heating up: 0.12 a, standby: 0.05 a
- Water pressure - max. 2,8 bar
- Max. temperature - 70 °c



## 70131-00 : Truma Boiler wall cowl extension

- Extends the flue from ultrastore heater by 50mm



## Whale Expanse onboard water heater, gas and electric with flue Kit

**SETWL8202A**

229 x 262 x 522 mm

- Onboard Gas and Electric Water Heater with Whale® Water Heater Control Panel, includes heater, control panel, cable, flue and flue brackets.
- Capacity: 8L , Wattage: 750 - 1500W , Gas Type : Butane or propane.



## Whale Expanse underfloor water heater, gas and electric with flue Kit

**SETWL8212A**

180 x 262 x 522

- Underfloor Gas and Electric Water Heater (Install with Whale iVan® Control Panel). Kit includes: 8L Water Heater , Control Panel , 3.5M Cable , 1.25M Flue , 3 x Flue Brackets, End Flue Bracket.
- Capacity: 8L , Wattage: 750 - 1500W , Gas Type : Butane or propane.



## Whale 8L gas and electric water heater

**WH0802**

258 x 329 x 391 mm

- The Whale Rapid Heat 8L Water Heater gives you extra fast heat up times as well as the flexibility of versatile gas and/or electric running options.
- Capacity: 8L , Wattage: 750 - 1500W , Gas Type : Butane or propane.



## Whale 13L gas and electric water heater

**WH1302**

- The Whale Rapid Heat 8L Water Heater gives you extra fast heat up times as well as the flexibility of versatile gas and/or electric running options.
- Capacity: 13L , Wattage: 600 - 1200W , Gas Type : Butane or propane.

# Water



## Whale Easi-Slide water inlet housing

**SO2000B**

270 / 164 x 103 mm

- Slick design - uniform look on the vehicle's exterior walls
- Waterproof protection
- High quality satin finish UV stabilised to prevent damage from sunlight
- Weight: 0.10kg
- Plumbing Connections: 40mm DIA pipe, 10mm DIA bleed pipe
- Materials in Contact With Water: ABS
- Compliance: IP55 rated when lid closed

*image above shown with housing lid including lock (purchased separately)*



## Whale Easi-Slide mains water outlet housing

**SO4000B**

- Slick design – uniform look on the vehicle's exterior walls
- Waterproof protection
- High quality satin finish UV stabilised to prevent damage from sunlight
- Plumbing Connections 12mm female
- Optional shower attachment
- Materials in Contact With Water PP, ABS, Hostaform, stainless steel, NBR, reinforced PVC
- Compliance IP55 rated when lid closed

*image above shown with housing lid (purchased separately)*



## Whale shower handset

**SO4100B**

- The Whale Compact Shower Attachment offers convenience, simply attach the detachable exterior compact shower to the Whale Water Outlet Easi-Slide socket.
- Moreover, the detachable shower is connected to a 2.6-metre hose and is recommended to be used with cold freshwater only.



## Whale housing lid water

**AK1428B: White**

**AK1448B: Grey**

**AK1481B: Black**

- The Whale Easi-Slide Water Outlet Lid is made to easily slide over the SO2000B or SO4000B water housing units giving you a full cover
- Without lock or keys



## Whale housing lid water including lock

**AK1432B: White**

**AK1452B: Grey**

**AK1485B: Black**

- The Whale Easi-Slide Water Outlet Lid is made to easily slide over the SO2000B or SO4000B water housing units giving you a full cover
- Complete with lock and 2 keys

## Fawo water filler with magnetic lock

**01724T10599W : Black**

**01724T10099W : White**

**01724T10499W : Grey**

120 x 140 mm



- Use with 40mm filler hose and 10mm breather hose
- Requires 90mm diameter hole
- Please note this product does not include cap



# Water



Fawo mains water Inlet with magnetic lock

**01746T40499 : Grey**  
**01746T40099 : White**

- Size: 140 x 130 mm , Magnetic door
- Brass speed fit connection
- Diaphragm shut off valve (NRV)



Fawo shower outlet with magnetic lock

**01746T70099 : White**  
**01746T70599 : Black**

- With extra rocker switch and spring-supported hinged lid including magnetic closure



Bullfinch shower point with temperature control

**6088/01 : White**    **6088/08 : Black**  
**6088/05 : Grey**

- Complete with a shower head assembly (shower fitting, shower hose and swivel head) and fixing screws



Fawo water filler cap

**01722T22084 : Zadi housing**  
**01722T20184 : HSC housing**

- Cylinder not included



Fawo water inlet & filler cap

**01622T64081E**

- Includes lock cylinder and 2 keys
- Diameter : 40 mm
- Black in colour



Fawo water filler locking cap

**01622T90281 : Black**  
**01622T90290 : White**

- Complete with cylinder and keys



Fawo water inlet and filler cap

**01622T64090W : White**

- 40mm diameter
- Complete with 2 keys



PVC Convuluted hose  
30M Rolls

**01589T21978 : 19mm inner**  
**01589T22078 : 20mm inner**  
**01589T22578 : 25mm inner**  
**01589T24078 : 40mm inner**

- 4 Widths available , 30M rolls

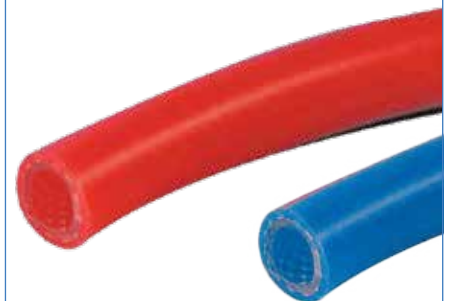

FAWO water pipe  
50M Rolls

**01589T21183 : Red : 10mm inner**  
**01589T21184 : Blue : 10mm inner**

- Red or blue water pipe
- 50M Rolls
- 10 mm inner diameter

# Water



Flojet 12v 30psi 5.6lpm pump

**R3426504B : OEM**

**R3426504A : Retail**

- Amps: 2.2a., Max.Fuse: 5a
- Flow: 1.4 gpm (5.3 lpm)
- Self priming
- Dry running
- Noise absorbing mounts
- Snap-in port fittings
- Corrosion resistant materials
- Operation without accumulator tank
- Built-in pulsation eliminator



Shurflo Trail King 10L 30PSI water pump 24V

**2095-473-143 : OEM**

533 x 281 mm

- Flow: 10.litres/min
- Pressure: 30psi , Usage: 4 amp
- Noise: 61db
- Weight: 2.0kg



Flojet John Guest port fitting kit

**21000686B : 12 mm**

- 20mm inside nut
- 12mm nozzle



Shurflo Trail King Water pump 12V

**OEM**

**2095-403-143 : 10L , 30PSI**  
**2095-204-112 : 7L , 20PSI**  
**2095-204-113 : 7L , 30PSI**

**Retail**

**2095-403-444 : 10L , 45PSI**  
**2095-204-412 : 7L , 20PSI**  
**2095-204-113 : 7L , 30PSI**



Shurflo Pre-charge accumulator 20 psi

**182-102 : OEM**

232 x 121 x 97 mm

**182-202 : Retail**

- Reduces pump cycling, Smooths water faucet pulses, Less noise
- Supported for industrial and marine, extends pressure switch-controlled pump life, saves battery power, less amperage draw, Max capacity: 125psi



Shurflo pump filter/strainer 1/2" BSP to John Guest

**255-215**

- Catches any dirt and keeps debris
- 1/2" inlet / outlet
- Easy to dismantle for cleaning
- Easy to install



Shurflo pump filter/strainer 1/2" BSP with the flexible hose

**255-225**

- Catches any dirt and keeps debris
- 1/2" inlet / outlet
- Easy to dismantle for cleaning
- Easy to install



Strainer/filter to suit flojet pump

**01740300B**



Shurflo connector

**244-3926 : Elbow**  
**234-2926 : Straight**

- 20mm inside nut
- 12mm nozzle

# Water



Comet VIP Plus 18l/min  
Submersible Pump

**62068**

- 18 l/m, 1.1 bar
- 35-45 watt



Comet Eco-Plus 12V 12L  
submersible pump

**0181360.79**

38 X 120 mm

- Power consumption 35 – 45 w
- Water flow max. 12 l/min
- Head max. 11 m, 1.1 ba



Comet in line pump 12V

**0181720.77**

- 19 litres/minute
- 1.0 bar



Reich Easy 14L pump

**513-0214**



Reich 18L pump

**514-0418E**



Reich 19L twin pump

**512-1914401A16**



Reich 25L powerjet pump

**514-0725ES**

# Water



Whale standard submersible pump

**GP1002**

- The whale standard submersible pump is a simple, compact and economical solution. It has a long life and is very quiet with a low power consumption.



Whale high flow submersible pump

**GP1652B**

- Simple compact and an economical solution
- Long life very quiet with low power consumption
- Suitable for use with pressure switch and micro switch systems



Whale inline booster pump

**GP1692**

- Self venting inline electric pump. Compact, quiet, lightweight design suitable for use with pressure switch and micro switch systems.
- Flow rate of 16 lpm
- 12V



Whale premium submersible pump

**GP1352B**

- Simple, compact economical solution, long life, very quiet with low power consumption, an inexpensive way to update a manual to an electric system.
- Flow rate of 13 lpm , Draw 3.6 amps , 12V



Whale premium inline pump

**GP1392**

- Self venting inline electric pump. Compact, quiet, lightweight design suitable for use with pressure switch and micro switch systems.
- Flow rate of 13 lpm
- 12V



Whale superfill pump kit

**GP1332**

- Whale Superfil water pump is an easy portable solution to fill on board tanks or containers.
- 12V DC premium submersible pump
- 1.5m black hose and 1.38m cable
- Two pin plug and 12V DC socket



Whale portable pump kit

**GP1642**

- This great performance and low voltage pump is easy to maintain with a wipe clean hose and nozzle. The Whale GP1642 pump kit is suitable for cold and warm water.



Whale Easi-Slide 12V water housing

**SO2500B**

- Whale Easi-Slide 12V water housing
- Waterproof protection, Voltage: 12V DC
- High quality satin finish UV stabilised to prevent damage from sunlight.
- Comfortable to use

*Please note :  
Image to the left  
shows housing  
with lid AK1429B  
which is purchased  
seperately*



Whale 230V housing lid

**AK1429B : White  
AK1449B : Grey  
AK1482B : Black**

- Whale Easi-slide lid that simply clicks into place and adds a colour coded lid

# Water



**CP Cleo basin**

**1022007** 520 x 660 x 430 mm

- Ideal for caravans where space is limited



**Contessa C400 tip up sink unit**

**1022005/3** 670 x 870 x 135 mm

- Formed to fit the C400 toilet



**CP Cleo cabinet**

**1072008** 540 x 520 x 110 mm



**CP Contessa cabinet**

**1072007** 670 x 530 x 130 mm

- Measures 80mm at top when closed



**CP shower tray**

**1042001** 585 x 585 x 10 mm

- Acrylic shower tray



**CP shower tray to suit C400 toilets**

**1042003** 1050 x 670 mm

- Acrylic shower tray
- Suits the Thetford C400 range of toilets
- Shower well dimensions: 1780 x 545 mm



**CP universal shower tray**

**1042002** 1050 x 705 mm

- Acrylic shower tray
- Shower well dimensions: 665 x 560 x 85 mm



**CP shower tray**

**1172090** 670 x 670 x 115 mm

- Acrylic shower tray

# Water



**Dometic  
SMEV VA8005  
rectangular  
sink**

**VA8005**

420 x 370 x 145 mm

- Completed by a black glass lid, with a stainless steel finish, Net weight: 2.7kg
- Folded over ends to soften any sharp edges, meaning a rubber seal is no longer required, making installation easier than ever



**Dometic  
SNG4133  
rectangular  
sink**

**9102305029**

410 x 124 x 335 mm

- Stainless steel rectangular sink with heat resistant safety glass lid.
- Includes seal and sink waste.
- Excludes tap and tap hole.



**Dometic  
CVS1350G  
vision sink**

**9600051161**

350 x 350 x 170 mm

- Single square sink
- Water tap hole
- Glass cover
- Soft close lid



**Dometic  
Smev  
VA7306FP  
round sink**

**9600027592**

420 x 148 mm

- Single round sink
- Water tap hole
- Glass cover
- Soft close lid



**Dometic  
VA928 sink**

**9600027593**

400 x 130 mm

- Single round sink
- No tap hole
- Glass cover
- Insulation dimension 366 mm
- Weight : 1kg



**Dometic SMEV AC540 angled waste fitting**

**9600050027 : 20 mm**

**9600050026 : 25 mm**

- Supplied with almost all the Smev/Dometic 9222, 9722, 8821 & 8005 units
- White body with a 90 degree bend
- Please note no chain supplied

# Water



Thetford  
Argent enamel  
sink  
Black

**SBL1053-SP**

153 x 360 x 470 mm

- Includes siphon waste, 9.5L capacity
- Surface mounted fixation, Glass lid
- Inside bowl: 99 x 290 x 368mm
- Net weight: 3.8kg
- Worktop cut-out: 335x430mm (wxd)



Thetford  
stainless steel  
sink

**SBL1052-SP**

153 x 360 x 470 mm

- Includes siphon waste, 9.5L capacity
- Surface mounted fixation, Glass lid
- Inside bowl: 99 x 290 x 368mm
- Net weight: 3.8kg
- Worktop cut-out: 335x430mm (wxd)



Thetford  
round bowl sink

**SBL3051-SP**

405 x 145 mm

- High quality materials and components
- Contemporary home like design
- Easy to clean, Optimal use of space
- Excellent finishing
- 3 year warranty



Thetford  
rectangular  
sink

**SBL3450-SP**

420 x 148 mm

- Easy to clean
- Matching hobs



Thetford Argent  
sink

**SSK1054-SP : Left**  
**SSK1055-SP : Right**

- Stainless steel bowl with drainer
- Optimal use of space

# Water



Dimatec Monolever shower mixer tap - Chrome

**0182008.10JG**

- Side water outlet connection for shower hose
- Suits hole diameter of 40 - 52 mm



Dimatec Monolever tap Chrome

**0182006.12JG**

Spout : 120 mm

**0182006.17JG**

Spout : 170 mm

- Pressure fed - no micro switch
- Monolever control tap for flow & temperature
- Tap hoses sold separately



Dimatec Monolever tap Matt chrome

**0182006.00P**

- 10cm spout
- Tap hoses sold separately
- Suits hole diameter of 40-52mm
- Complete with anchorage kit



Comet Florenz cold water tap

**0182361.20JG : John guest tails**  
**0182361.20 : Barbed fittings**

- Includes Parma handle
- Complete with micro switch



Comet Florenz mixer tap

**0182393.20JG : John guest tails**  
**0182393.20 : Barbed fittings**

- Mixer tap complete with micro switch
- Barbed fittings 33mm installation



Dimatec fixed shower bracket Chromed

**0183020.59**

- Comes complete with fittings



Dimatec 300mm flexi tap hose JG end RED/BLUE

**0183033.16**

- Flexi tap tail with john guest end. red/blue
- Accepts 12mm john guest pipe
- Order separately, (must order 2 1 blue 1 red)



Dimatec 300mm ribbed flexi tap hose with barbed end

**0183033.12**

200 x 60 x 85 mm

- Fits into flexible water pipe
- Must order in 2's



# Water



Comet London cold water tap

**0182201.22** 200 x 60 x 85 mm

- Comes with micro switch, cold water only
- Adjustable, Min. mounting hole: 22mm
- Minimum height 40mm
- Spout length: 150mm
- 100mm barb connector



Comet London bathroom cold water tap

**0182203.22**

- Comes with micro switch and aerator
- 22mm mounting hole
- Adjustable jet



Comet London kitchen mixer water tap

**0182217.22.24**

- Not micro switched
- The single lever control makes it easy to adjust water flow and temperature
- 12mm barb fitting



Comet London cold water tap

**0182201.22.24**

- Not micro switched
- The single lever control makes it easy to adjust water flow and temperature
- 12mm barb fitting



Comet London bathroom mixer tap

**0182218.22**

- Hot and cold mixer tap



Dimatec Monobloc tap with fold down spout - Chrome

**0182005.LX** 200 x 60 x 85 mm

- Dual control monobloc tap
- Spout folds to either side giving maximum height of 40mm
- Suits hole diameter of 40-52mm
- No tails



Samba tap

**573-0570301 : Cold water tap**  
**575-0570301 : Mixer Water tap**

- Barbed ends tap has 250 mm flexi hose
- Barbed ends
- Micro switched , 33 mm cut out



Keramik Samba mixer tap

**575-040060CP: Barbed end**  
**575-0400601: Push fit**

- Barbed ends tap has 250 mm flexi hose
- Push fit tap has 250 mm unquick pipe
- Micro switched , 33 mm cut out



Vector S mixer tap

**570-7000001 : Barbed end**  
**570-700000CP: Push Fit**

- Barbed ends tap has 250 mm flexi hose
- Push fit tap has 250 mm unquick pipe
- Micro switched , 33 mm cut out

# Water



Vector E mixer tap

**570-7020501 : Barbed end**  
**570-702050CP : Push fit**

- Barbed ends tap has 250 mm flexi hose
- Push fit tap has 250 mm unquick pipe
- Microswitched , 33 mm cut out



Trend A cold water tap

**554-0400001: Barbed end**  
**554-040000CP: Push fit**

- Barbed ends tap has 250 mm flexi hose
- Push fit tap has 250 mm unquick pipe
- Micro switched , 27 mm cut out



Trend A cold water tap

**554-0400101: Barbed end**  
**554-040010CP: Push fit**

- Barbed ends tap has 250 mm flexi hose
- Push fit tap has 250 mm unquick pipe
- Microswitched , 33 mm cut out



Trend A mixer tap

**553-0400001: Barbed end**  
**553-040000CP: Push fit**

- Barbed ends tap has 250 mm flexi hose
- Push fit tap has 250 mm unquick pipe
- Microswitched , 27 mm cut out



Trend A mixer tap

**553-0400101: Barbed end**  
**553-040010CP: Push fit**

- Barbed ends tap has 250 mm flexi hose
- Push fit tap has 250 mm unquick pipe
- Micro switched , 33 mm cut out



Trend E mixer tap

**571-8020101: Barbed end**  
**571-802010CP: Push fit**

- Barbed ends tap has 250 mm flexi hose
- Push fit tap has 250 mm unquick pipe
- Microswitched , 33 mm cut out



Linnea K black mixer tap

**568-7030001SKM : Barbed end**  
**568-703000CPSKM : Push fit**

- Barbed ends mixer has 250 mm flexi hose
- Push fit mixer has 250 mm unquick pipe
- K bathroom model with 154 mm tap height
- Micro switched
- 33 mm hole cut out



Linnea K chrome mixer tap

**568-7000001SKM: Barbed end**  
**568-700000CPSKM: Push fit**

- Push fit mixer has 250 mm unquick pipe
- L kitchen model with 200 mm tap height
- Micro switched
- 33 mm cut out



Linnea L black mixer tap

**568-8030001SKM: Barbed end**  
**568-803000CPSKM: Push fit**

- Push fit mixer has 250 mm unquick pipe
- L kitchen model with 200 mm tap height
- Micro switched
- 33 mm cut out

# Water



Linnea L silver mixer tap

**568-8000001SKM: Barbed end**  
**568-800000CPSKM: Push fit**

- Push fit mixer has 250 mm unquick pipe
- L kitchen model with 200 mm tap height
- Micro switched , 33 mm cut out



Keramik Twist shower mixer  
(39mm hole)

**575-0409001: Barbed end**  
**575-040900CP: Push fit**

- Barbed ends mixer has 250 mm flexi hose
- Push fit mixer has 250 mm unquick pipe
- 39 mm cut out



Dimatec extractable shower set  
Chrome

**0182012.01X**

- Suits hole diameter of 40-52mm



Dimatec shower set and riser  
Chrome

**0183022.99C**

- Complete riser bar, hose and headset for showers
- Includes fully flexible shower hose & all fittings
- Suits mixer and as a general replacement
- Anti calcium head



Comet Florenz shower mixer

**0182385.20.61**

- Single lever control
- Shiny chrome finish
- 12mm barb fitting



Kama shower mixer  
(Julia head and hose)

**572-800000661CP : Push fit**

- Push fit mixer has 250 mm unquick pipe
- 36 mm cut out



Charisma shower head

**0.907900**



Julia shower head

**540-35000**

# Water



- The world's largest water control valves and push-fit systems manufacturer
- Precision-engineered for lasting performance, speed, and ease of installation
- Instant push-fit connectors, couplers, reducers and more
- Connection and demountable without tools
- Suitable for piping systems up to 10 bar
- Food grade fitting suitable for potable liquids



John Guest equal TEE

**PM0210E : 10 mm**  
**PM0212E : 12 mm**

- Order in 10's



John Guest 12mm 2 way divider

**RM2312E : Black**  
**PPM2312W : White**

- Order in 10's



John Guest equal elbow

**PM0312E : 12 mm**  
**PM0315E : 15 mm**

- Order in 10's



John Guest straight connector

**PM0410E : 10 mm : Black**  
**PM0412E : 12 mm : Black**  
**PEM0415W : 15 mm : White**

- Order in 10's



John Guest straight reducer

**PPM201512W : 15 - 12 mm : White**  
**PM201210E : 12 - 10 mm : Black**

- Order in 10's



John Guest stem reducer

**PM061210E : 12 - 10 mm : Black**  
**PPM061512W : 15 - 12 mm : White**  
**PM061512E : 15 - 12 mm : Black**

- Order in 10's



John Guest reducing elbow

**PM211210E : 12 - 10 mm : Black**

- Order in 10's



John Guest stem elbow

**PM221212E : 12 mm : Black**  
**PEM221515W : 15 mm : Black**

- Order in 10's



John Guest shut off valve

**PPMSV041010W : 10 mm**  
**PPMSV041212W : 12 mm**

- Order in 10's

# Water



- The world's largest water control valves and push-fit systems manufacturer
- Precision-engineered for lasting performance, speed, and ease of installation
- Instant push-fit connectors, couplers, reducers and more
- Connection and demountable without tools
- Suitable for piping systems up to 10 bar
- Food grade fitting suitable for potable liquids



John Guest to BSP female adaptor

**CM451214FS** : 12 mm - 1/2 inch  
**CM321216E** : 12 mm - 3/4 inch  
**CM451213FS** : 12 mm - 3/8 inch

- Order in 10's



John Guest to BSP female adaptor

**PM451215FE** : 12 mm - 5/8 inch  
**PSE3203W** : 15 mm - 3/4 inch

- Order in 10's



John Guest straight threaded adaptor

**PM011204E** : 12 mm - 1/2 inch  
**PM011213E** : 12 mm - 3/8 inch

- Order in 10's



John Guest 12mm to 1/2 inch BSP threaded adaptor

**PM011214E** : 12 mm - 1/2 inch

- Order in 10's



John Guest acetal swivel elbow (BSP Thread)

**PM091213E** : Black

- Order in 10's



John Guest 12mm bulkhead fitting

**PM1212E**

- Box qty : 5's



John Guest tank connector

**CM0715S** : 15 mm

- Order in 10's



John Guest hose connector

**NC448** : 15 mm - 1/2 inch

- Order in 10's



Truma JG 12mm to 1/2 inch barb hose adaptor

**40060-91000**

- Order in 10's

# Water



- The world's largest water control valves and push-fit systems manufacturer
- Precision-engineered for lasting performance, speed, and ease of installation
- Instant push-fit connectors, couplers, reducers and more
- Connection and demountable without tools
- Suitable for piping systems up to 10 bar
- Food grade fitting suitable for potable liquids



John Guest single check valve

**12SCV : 12 mm**

- Order in 10's



John Guest inserts

**TSM1209S : 12 mm**

- Order in 100's



John Guest plug

**PM0812R : 12 mm**

- Order in 10's



John Guest end stop

**PM4612E : 12 mm**

- Order in 10's



John Guest locking clips

**PM1812R : 12 mm**  
**PIC1816R : 1/2 inch**

- Order in 100's



John Guest collet clips

**CM1815W : 15 mm**

- Order in 100's



John Guest pipe clip

**PC12W : 12 mm**

- Order in 50's



John Guest flow bend clips

**PM2612S : 12 mm x 1/2 inch**

- Order in 5's



Truma JG non return valve

**70160-52**

- Order in 10's

# Water



John Guest 12mm hose  
(100m coil)

**PE1209-100M-B : Blue**  
**PE1209-100M-R : Red**

- John guest 12m water hose 100 metre coil,
- Priced per meter.
- Purchased in 100m rolls



John guest pipe cutters

**JGTS**

- John guest piper cutter for up to 22mm tube
- Quick and easy to use



John Guest tube cutter

**TSNIP**

- Small cutting tool ensures clean and square cutting of drinking water tubing up to 12 mm in diameter



Hose connector , straight

W4	Fawo	
--	<b>01622T21090</b>	10 mm
<b>37838</b>	--	12 mm
<b>37841</b>	<b>01626T01987</b>	19 mm
--	<b>01626T02587</b>	25 mm

- 12 mm = 1/2 inch , 19 mm = 3/4 inch



Hose connector , straight

**00078 : 28.5 or 32 mm**

- Straight connector for 28.5 or 32 mm hose.
- Use the inside of the pipe for 28.5 and the outside for 32 mm



Hose connector , straight reducer

**37837 : 12 to 10 mm**

- Straight reducer from 12 mm to 10 mm
- 12 mm = 1/2 inch , 19 mm = 3/4 inch



Hose connector , Y

W4	Fawo	
--	<b>01626T21087</b>	10 mm
<b>37839</b>	<b>01626T21287</b>	12 mm
<b>37842</b>	<b>01626T21987</b>	19 mm

- 12 mm = 1/2 inch , 19 mm = 3/4 inch



Hose connector , Y

**00088 : 28.5 or 32 mm**

- Y connector for 28.5 or 32 mm hose.
- Use the inside of the pipe for 28.5 and the outside for 32 mm



Hose connector , T

W4	Fawo	
<b>37840</b>	<b>01626T31287</b>	12 mm
<b>37843</b>	--	19 mm

- 12 mm = 1/2 inch , 19 mm = 3/4 inch

# Water



Hose connector , elbow

**37805: 12 mm**  
**01626T41987 : 19 mm**

- 12 mm = 1/2 inch , 19 mm = 3/4 inch



Angled connector

**1445605 : 40 mm (1 1/4 inch BSP)**  
**1446605 : 20 mm (3/4 inch BSP)**

- Blue
- Sold in bags of 10
- C/W Nut and washer



Straight connector

**1447605 : 10mm (3/4 Inch BSP)**

- Blue
- Sold in bags of 10
- C/W Nut and washer



DLS 3/4" Outlet hose socket  
 Grey

**1051440**



P Clips

**01589T81699 : 16 mm**  
**01589T81999: 19 mm**  
**01589T82899: 28.5 mm**

- Multiples of 100



P Clips

**01589T80799 : 6.5 mm**  
**01589T80999: 9 mm**

- Multiples of 100



8mm Protected P Clips

**01589T60799: 8 mm**

- Multiples of 100
- Comes with chloropren protector



Special hose clips

**01589T91935 : 19 mm**  
**01589T92535: 25 mm**  
**01589T94035 : 40 mm**



Tank connector, angled

**01622T32090 : 20 mm**



# Water



Tank connector, elbow

**01622T34090 : 40 mm**

- Elbow with seal and nut
- White



Tank connector, straight

**01622T21090 : 10 mm**

**01622T32090 : 20 mm**

**01622T22590 : 25 mm**

- Straight with seal and nut
- White



T5 57L fresh water tank

**A353**

100 x 200 x 300 mm

- Fittings not included
- The unique curve enables it to fit around the wheel arch of the t5



48L water tank for T5/T6 with bracket & fittings

**A355**



White inspection hatch cover

**40040**

145 mm

- Screw inspection covers
- Built in "o" ring to seal
- Aperture: 103 mm, Cutting: 114 mm



CKW Dust cap and ring

**77-17-1033 : Dust Cap**

**77-12-1113 : Cap ring**

- Dust cap has a hole for the pump

# Water



20L water container

**010/2013**

270 x 480 x 170 mm

- 20L Capacity
- Food grade plastic
- Reflects heat
- Designed to fit internally



Reimo T5 water tank

**60028 : 12L**

**60012 : 16L**

**60011 : 13L**

**60013 : 19L**

- With integrated handle
- Without lid
- Wide neck
- Integrated handle



CKW Water container (no cap)

**207-001000 : 10L**

**207-001900 : 19L**



CKW Water container (no cap)

**208-001000 : 9L**

120 x 415 x 260 mm

**208-411000 : 10L**



CKW cap with seal

**77-12-1102**

- To go with part number 77-17-1033



CKW Red bulkhead fitted barbed both ends

**74-11-460K**

Diameter: 12 mm

- Used for submersible pump, by connecting it to the water hoses
- Suitable for the water tank to air it. for this, you can mount it on top of the water tank

# Electrical



**Dimatec Chrome Recessed LED Spot Light**

**200SMB1.2-18CR**

**200SMB1.2CRT : Touch, default off**

**200SMB1.2CRTX : Touch, default on**

- Fits into a hole of approximately 54mm diameter (no screws required) and connection is via flying leads
- 65mm diameter, Warm white



**Dimatec Nickel Recessed LED Spot Light**

**200SMB1.2-18NS**

**200SMB1.2NST : Touch**

- 18 LEDs provide warm light
- Energy efficiency class: a
- Lumen: 3200 lm
- Installation dimensions 65x15mm
- Voltage: 12 v - Power: 1.2 w - Weight: 35 g



**Dimatec mirror finish round slim touch light**

**200MLR2.2D : 2.2 W**

**200MLR3.2D : 3.2 W**

**200MLR4.7D : 4.7 W**

- Blue night light, White main light
- Approximately 10mm from the mounting surface, Trim covers & screws included
- Diameter: 70mm - thickness 10mm



**Dimatec Recessed minispot chrome**

**200MSJ0.6CR**

- Plastic body with metal trim
- Cable length: 200mm (approx.)
- Cut-out hole required: 35mm dia. (approx.)
- Protrusion from mounting surface: 1.3mm
- Overall dimensions: 45 (dia) x 16 (d) mm



**Dimatec Nickel adjustable touch downlight**

**200ELO18NSTM**

- 65mm diameter flush fitting
- Tilts within the housing, to direct the light through 360°
- Fits hole 52mm diameter (no screws required) & connection is via flying leads



**Dimatec Black recessed minispot**

**200MSR1N**

- 12v-1.47w
- 38lm
- Diameter : 35 mm
- Diameter cutout 32 mm
- 3000k



**Dimatec recessed black spotlight**

**200CA0.4NIPD**

- Recessed ip65 spotlight
- LED 12 v - 0.4 w / 4,000 °k
- Neutral white 25 lm
- Outer ø 30 mm / recess ø 22 mm



**Dimatec 30mm Chrome recessed minispot**

**200CA0.4CRIP**

- Dimatec ip65 0.4w chromed stainless steel recessed spot 3,000 °k with 30mm diameter, 22mm cutout



**Dimatec Chrome Recessed mini spot with LED**

**200RLS0.06PCR1 : Cold white**

**200RLS0.06PCR : Warm white**

**200RLS0.06BCR : Blue**

- 12 v - 0,21 w, 1,5 lm
- Diameter: 18 mm, diameter cutout 14 mm

# Electrical



Round recessed LED Downlight

**K01-0130PCNW**

- Control LED via switch
- 12V DC, 2W
- Chrome, 4K, diameter 65mm, natural white
- 30cm cable plus 6.3mm spade connectors



Round recessed LED Downlight

**K01-0130TDPCNW : Touch**

- Control LED via touch
- 12V DC, 2W
- Chrome, 4K, diameter 65mm, natural white
- 30cm cable plus 6.3mm spade connectors



Fawo LED Surface Light with nightlight

**01637T55099**

- Diameter: 130mm - thickness 10mm



Fawo Magma LED bunk light

**01637T94097**



Dimatec Oval LED ceiling light

**200PLG3X3BNA**

- 3 x 3w power LED. 6 x 0,07w blue LED
- Size 340 x 125 x 40 mm (L x W x D)
- Three way switch



Dimatec mirror finish 6.3 w rectangular slim touch light

**200MLRC6.3D**

- Integrated dimmer
- 12v - 6.3w / 12 \*5630 LED
- 220mm length, 110mm width, 10mm depth



Dimatec White awning light

**030LEV11**

- Unswitched 11w output
- Size. 380 x base 115 x 40mm deep



Dimatec awning light

**200AW5S : Silver**

**200AW5B : White**

**200AW5N : Black**

- - 2v vdc/5w, Pre wired
- - 10 LED, 365mm length, 55mm profile



Dimatec Ducato sliding door light

**200VAN-PRO-UK**

- - 1.5 metres in length
- - 12 V - 8,50 W, 425 Lm
- - Neutral white: 4000 °K
- - IP65

# Electrical



**Dometic RainTec RT100 RHD  
Illuminated Rain Gutter**

**9106505339 : Jet black**  
**9106505340 : White**

- Installs above the sliding door on fiat Ducato, Citroën Jumper and Peugeot Boxer vehicles (RHD) from 2006 onward



**Dimatec LED-BAR 1000 mm  
12V T/S**

**200SLB1000T : 3000K**  
**200SLB1000TD : 4000K**



**Luxlite 12W IP20 RGBW  
(RGB+4500K) 10 mm**

**LUX-12V12WIP205MRGB**

- Luxlite 12w IP20
- RGBW (RGB+4500k) 10 mm



**Luxlite 12v cool white IP20 LED  
strip**

**LUX-12V6WIP20-5M-CW : 5M**  
**LUX-12V6WIP20-50M-CW : 50M**

- It will fit in Flat profile as the tape should only be 8mm in width, the connectors should also be 8mm
- 12V , 6W, IP20



**Luxlite 12v warm white IP20  
LED strip**

**LUX-12V4WIP20-50M-WW : 50M**

- It will fit in Flat profile as the tape should only be 8mm in width, the connectors should also be 8mm
- 12V , 4W, IP20



**Luxlite 12v/12w RGB IP20 LED  
strip**

**LUX-12VWIP20-5M-RG : 5M**

- It will fit in Flat profile as the tape should only be 8mm in width, the connectors should also be 8mm
- 12V , 12W, IP20



**Dimming/CCT/RGB/RGBW  
Receiver**

**LUX-SLV-VP-REC**

- Controller type: dimming/cct/rgb/rgbw
- Working frequency: 2.4ghz
- Input voltage: 12-24vdc
- Current: 3a x 4ch
- Power: 12v



**Luxlite 4 Zone RGB  
Control**

**4ZRGBW-RC**



**Luxlite RGBW Controller**

**LUX-RGBW-RC**

- Working frequency: 2.4ghz
- Working voltage: 3vdc
- Working current: <20ma
- Remote option: single zonerf
- Remote distance: max 30m

# Electrical



**8mm IP20 Strip to Strip connector**

**LUX-8MM2CSTS-IP20**

- Luxlite 2 core, 8mm LED strip to strip connector ip20 – lux-8mm2csts-ip20



**RGB Strip to Wire Connector IP20**

**LUX-RGB-STW-IP20**



**Luxlite 8MM strip to strip connector IP65**

**8MM2CSTS-IP65**

- 8mm strip to strip connector ip65



**10mm PCB 5 Pin RGBW Strip Connector**

**LUX-10MMRGBW-CON**



**LED Strip 10M Flat Surface Profile**

**LUX-10MSMF-OC**

- 10m surface flat profile inc. opal cover & fixings pack
- 1 tube of 5x2m



**LED strip connector 8mm tape**

**LUX-8MMCOB-STW-2M**

- Type: strip to wire, 2 pin
- 8mm single colour, ip20, fcob&>=240LEDs/m
- Working wire gauge: 20awg/0.5mm2
- Max voltage / current: dc36v/5a
- Working environment: 10~45°C



**Dimatec Chrome flexi Touch light with dual colour**

**200FXA2CRBT**

- The touch button cycles through 4 modes
- Voltage: 12V , Wattage: 1W
- The light is approximately 230mm overall length with a sturdy metal body and chrome plating



**Dimatec flexi switched reading light with dual colour**

**200FXA2CRRB**

- Made with high quality chrome and with an acrylic lens, these LED lights are built to last
- Voltage: 12V , Wattage: 1W



**Dimatec Satin Nickel Spotlight**

**200SZ1NST**

- 4000K LED
- Low power consumption 1w power LED
- Touch sensitive on/off switch
- Rotation & angle adjustable
- No dimmer function

# Electrical



**Dimatec Chrome 12v 1w LED reading light**

**200FAA2CRRB : Switch**  
**200FAA1CRTD : Touch**

- Dimatec 12v - 1 watt power LED reading light
- Base 60mmx21mm
- 1.5w+0.5w, 4000k/ blue light, 50lm, Ip20



**Nano LED Cylinder Locker Spotlight**

**K00-1000UPCNW : With USB charger**  
**K00-1000PCNW : No USB charger**

- Surface mounted, natural white
- 30cm cable plus 6.3mm spade connectors
- 4k , 12v , 2w



**Nano LED Cylinder Spot Light & USB Charger**

**K00-1000UMBW**

- Lumens: 4000K
- Voltage: 12V , Wattage: 2W



**Hafele Loox5 LED Flexible Reading Light**

**833.74.088 : Black**  
**833.74.089 : Chrome**

- Integrated dimmer, 12v - 6.3w / 12 \*5630 LED
- 220mm length, 110mm width, 10mm depth
- **NOTE** : You also need to order : 833.95.789



**Fawo Black LED Swan light with USB**

**01637T80581 : Swan F**

- Fawo LED swan light complete with usb
- Black in colour
- Voltage: 12V , Wattage: 1.2W , usb 1 amp



**Fawo LED Swan Light With Dimmer**

**01637T79081**

270 x 60 x 60 mm

- - Fawo LED swan light with dimmer
- - 3 amp
- - usb (4k)
- - 2w



**Fawo Mamba flexi LED light**

**01637T37299**

- 12 LED's.
- Flexible tube 325mm
- Head 84 x 46mm



**Dimatec black flexible reading light with USB**

**200FXSN1.5U**

- 12 v - 1,50 w, 130 lm
- Warm white: 3400 °k
- Diameter: 50 mm, 350mm length
- IP20 5v - 2,1a
- USB



**Dimatec Chrome Flexi LED with USB**

**200FX1CR-U**

- Warm white
- 12v-1w, 50lm, 3000k
- 60mm base

# Electrical



## Sterling Pure Sine Wave Inverter PS series RCD

**PSRCD121500**

- Pure Sine inverters are designed to perfectly replicate AC as you get it from your mains supply, ensuring that all of your 230V appliances run correctly.
- Voltage: 12V, Wattage: 1500W, RCD



## Sterling Pure Sine Wave Inverter

**SIB121000 : 1000W**  
**SIB121600 : 1600W**

- Pure Sine inverters are designed to perfectly replicate AC as you get it from your mains supply, ensuring that all of your 230V appliances run correctly.
- Voltage: 12V



## Sterling Pro Power Q Inverter

**I12600 : 600W**  
**I12800 : 800W**  
**I121000 : 1000W**  
**I121800 : 1800W**

- Sterling power quasi sine wave inverter.
- Converts 12V to 230V



## Voltage Sensitive Relay

**4015**

- Charges two x 12 v batteries from one engine
- 140 amps rating
- Eliminates draining from starter battery



## Black Mini Pop-Up Socket with wireless charger

**N28-0401BL** 70 x 50 mm

- Input: 12v-24v 2a with 1.4m 2 x 0.34mm<sup>2</sup> input cable, LED mini plug
- Output 1 (wireless charge): 5w/7w/10w
- Output 2/3 (usb1/2): 5w max
- Transmission distance: ≤ 8mm



## CBE Battery Charger MOD. BC122

**B1.0543.002** 146 x 183 x 65mm

- Rated voltage : 230Vac +-10%
- Frequency : 50Hz+60Hz
- Max power : 320W
- Protection fuse : 4A
- Maximum current : 22A continuous



## CBE CB516-3 12V/16A switchmode battery charger

**321516**

- Includes all cables & connectors
- Water tank probes sold separately



# Electrical



**Sterling battery to battery charger + 350W solar controller**

**BBS1230**

- Sterling's range of battery to battery chargers (b2bs) has grown significantly over the past few years. this is in an effort to supplement the ever growing demand from the commercial vehicle, recreational vehicle and marine industries. The B2B's have become extremely popular as they fast charge batteries as you cruise along without the need for complex wiring, touching your alternator, voiding the alternator's warranty and tampering with the electronic control units (ecus).
- 12v 30a specification
- Easily install LED with no complicated wiring
- 1a back feed to maintain starter battery
- 3 stage battery charging program



**Sterling Battery to battery 60 amp charger**

**BB1260**

- Fast charge batteries as you cruise along without the need for complex wiring, touching your alternator, voiding the alternator's warranty and tampering with the electronic control units (ecus)



**Sterling Battery to battery 30 amp charger**

**BB1230**

- 12v 30a and 3 stage battery charging program
- Easily install with no complicated wiring
- Default mode complements regenerative braking and does not require ignition feed and additional modes with ignition feed and timer



**Sargent 20A DC-DC 3 Stage Battery Charger**

**DX320-12**

- Power 260w
- Input voltage range 10.5 - 15.4v
- Output voltage range 8 - 16v
- Output current 20a (max)
- Standby current 17ma (max)



**Sargent 2 Stage 192w Battery Charger**

**PF200**

200 x 63 x 35 mm

- IN: 230v ac 50hz 2.4a | OUT: 13.8v dc 192w
- Weight: 0.84 kg
- Input connection: stripped and prepared ends
- Output connection: 2x insulated blade terminals (6.3mm / 1/4")



**Sargent 20A DC-DC 3 Stage Battery Charger**

**PX310**

221 x 157 x 67 mm

- Power : 300W, Input Voltage : 200-240VAC
- Charging Current (max) : 20A @14.5V
- Voltage : Boost: 14.7V (max), float: 13.8V
- Compatible batteries : Flooded, Gel, AGM, Lithium, Battery size : 70 - 220A

# Electrical

We at Miriad Quest Leisure have teamed up with Platinum International and the implementation of the NCC verified battery scheme shows you why. Platinum have one of the largest selection of NCC verified battery ranges available from any manufacturer.

This means that you can get any battery, for any purpose from one single supplier, making it easier than ever before.

**PLATINUM**  
INTERNATIONAL

## NCC VERIFIED



The National Caravan Council (NCC) was setup over 70 years ago as the UK trade body representing the collective interests of the touring, Motorhome, holiday home and park home sectors.

The scheme provides product verification for batteries used in leisure vehicles. With modern leisure

vehicles featuring more technology and electrical appliances than ever before, buying an NCC verified leisure battery will give you confidence that the battery purchased is fit for purpose and will perform as advertised. The batteries will be verified and labelled accordingly into three categories, A, B and

C, depending on their category & purpose. The NCC don't verify or test batteries designed for RVs.

Used in conjunction with the NCC Scheme supports the style of selecting the battery based on the users usage requirements below:

## CLASSIFICATIONS

**Class A** is for batteries with a higher storage capacity, for people who frequently use their caravans or motorhomes away from electrical hook-ups and require high power to operate devices such as microwaves and motor movers. Class A verified batteries typically have 10x more cycles than a Class C Battery.



**Intended Purpose:**

Frequently used without electrical hook-up.

**Note:** For motorhomes with higher power consumption but still generally used without electrical hook-up, it may be more practical to use multiple batteries from class A.

**Class B** batteries are aimed at those who frequently use sites with hook-up facilities, but require a greater battery capacity to operate TVs and other devices. Class B verified batteries typically have 3x more cycles than a Class C Battery.



**Intended Purpose:**

For use with electrical hook-up with minimal off-grid habitation usage e.g. Lights, TV plus motor mover

**Class C** is for users that require a lower capacity battery to cover basic operation of their habitation equipment for short periods away from a hook-up.



**Intended Purpose:**

For use with electrical hook-up with minimal off-grid usage e.g. Lights

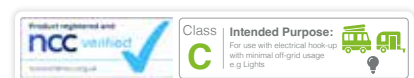
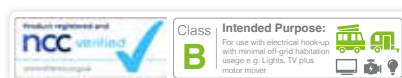
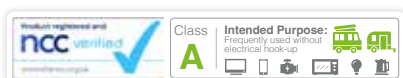

# Electrical

## PLATINUM LEISURE AGM PLUS

### FEATURES

- DESIGNED TO COPE WITH THE ARDUOUS DEMANDS PLACED ON THE BATTERY BY THE MOTOR MOVER.
- ADVANCED PLATE DESIGN WHICH GIVES HIGH RESISTANCE TO CORROSION AND REDUCES SELF DISCHARGE, SO OFFERS GREATER STORAGE TIME
- ABSORBED GLASS MAT SEPARATORS WHICH INCREASE CYCLIC CAPABILITY ALLOWING THE BATTERY TO BE DISCHARGED AND RECHARGED OVER 360 TIMES, RESULTING IN LONGER SERVICE LIFE
- SEALED CONSTRUCTION WHICH ENSURES NO ELECTROLYTE LEAKAGE FROM TERMINALS OR CASE. THIS ALLOWS FITMENTS IN ANY ORIENTATION
- SEALED LOW-BOX - IDEAL WHERE THE FITMENT LOCATION OF THE BATTERY IS RESTRICTED



Specifically  
Designed for



Motor Movers

360 CYCLES



Class

A

Intended Purpose:  
Frequently used without  
electrical hook-up



For motorhomes with higher power consumption but still generally used without electrical hook-up, it may be more practical to use multiple batteries from class A.

## PLATINUM LEISURE PLUS EFB

### FEATURES

- SEALED LOW-BOX - IDEAL WHERE THE FITMENT LOCATION OF THE BATTERY IS RESTRICTED
- HIGH CARBON CONTENT IN NEGATIVE PLATE INCREASED CHARGE ACCEPTANCE
- IMPROVED DOUBLE LAYER SEPARATORS INCLUDING A POLYESTER FIBRE SOFT LAYER LONGER LIFE
- LARGE ELECTROLYTE RESERVOIR INCREASED CYCLES
- TIN ALLOY IN GRID CONSTRUCTION LONGER LIFE
- SPILL PROOF TO 55° ANGLE MAINTENANCE FREE



200 CYCLES



Class

B

Intended Purpose:  
For use with electrical hook-up  
with minimal off-grid habitation  
usage e.g. Lights, TV plus  
motor mover



# Electrical



70 CYCLES



Class **C** Intended Purpose: For use with electrical hook-up with minimal off-grid usage e.g Lights

## PLATINUM LEISURE & LEISURE PLUS

### FEATURES

- SEALED LOW-BOX - IDEAL WHERE THE FITMENT LOCATION OF THE BATTERY IS RESTRICTED
- HIGH CARBON CONTENT IN NEGATIVE PLATE INCREASED CHARGE ACCEPTANCE
- IMPROVED DOUBLE LAYER SEPARATORS INCLUDING A POLYESTER FIBRE SOFT LAYER LONGER LIFE
- LARGE ELECTROLYTE RESERVOIR INCREASED CYCLES
- TIN ALLOY IN GRID CONSTRUCTION LONGER LIFE
- SPILL PROOF TO 55° ANGLE MAINTENANCE FREE



100+ CYCLES



Class **A** Intended Purpose: Frequently used without electrical hook-up

## PLATINUM VRLA

### FEATURES

- THE VRLA RANGE IS NOT ONLY USED AS BACK UP POWER, IT IS IN FACT USED IN A NUMBER OF APPLICATIONS WHERE IT IS THE ONLY POWER SOURCE, THEREFORE DURABILITY AND RELIABILITY ARE A GIVEN.
- THE PLATINUM VRLA RANGE OF BATTERIES IS IDEAL WHEN 'OFF GRID' POWER IS REQUIRED ON A FREQUENT BASIS.



## ENGINE STARTER

As this is a starter battery, used for Motorhomes, it does not have a National Caravan Council classification.

## PLATINUM MOTORHOME

### FEATURES

- 30% EXTRA POWER - PERFECT FOR ENGINE STARTING AND RUNNING ELECTRICAL APPLIANCES
- S O C I (STATE OF CHARGE INDICATOR) - USES COLOURS TO INDICATE THE CHARGE OF THE BATTERY
- ABSORBED GLASS MAT SEPARATORS - INCREASES CYCLIC CAPABILITY ALLOWING THE BATTERY TO BE DISCHARGED AND RECHARGED MORE, RESULTING IN LONGER SERVICE LIFE
- SEALED CONSTRUCTION - UNIQUE CONSTRUCTION ENSURES NO ELECTROLYTE LEAKAGE FROM TERMINALS OR CASE. THIS ALLOWS FITMENTS IN ANY ORIENTATION
- GAS RECOMBINATION - RECOMBINES ANY GASSES CREATED DURING NORMAL USAGE, TOTALLY MAINTENANCE FREE
- SEALED LOW-BOX - IDEAL WHERE THE FITMENT LOCATION OF THE BATTERY IS RESTRICTED

# Electrical

## SCRAP £££

"WE WANT YOUR OLD BATTERIES!"

### MONEY

You get money for your scrap returns. You can levy an environmental disposal charge.

### IT'S A LEGAL REQUIREMENT

We provide a fully legally compliant scrap battery collection service.

### DUTY OF CARE

Protect our environment by recycling responsibly.

### COLLECTION

We can collect in 1's & 2's with our hassle free frequent collection service.



## SPECIFICATION TABLE

Platinum Part Number	Category	NCC Rating	V	Ah C20	CCA (EN)	Length (mm)	Width (mm)	Case height (mm)	TL Height (mm)	Layout	Terminal	Hold Downs	Cycles @50%
AGM019E	Starter	N/A	12	95	850	354	175	190	190	0	T1	B13	N/A
AGMLB6110L	Leisure AGM	A	12	100	N/A	354	175	190	190	0	T1	B13	360
EFBS685L	Leisure EFB	C	12	75	N/A	258	172	200	222	1	T1	B07	200
EFBLB6110L	Leisure EFB	B	12	100	N/A	354	175	190	190	0	T1	B13	200
SD690L	Leisure Plus	C	12	90	N/A	302	170	200	222	1	Dual post	N	70
LB6110L	Leisure Plus	C	12	100	N/A	351	174	188	188	0	T1	B13	70
S6110L	Leisure Plus	C	12	110	N/A	328	171	215	237	1	T1	N	70
SD6110L	Leisure Plus	C	12	110	N/A	328	171	215	237	1	Dual post	N	70
S685L	Leisure Plus	C	12	75	N/A	258	172	200	222	1	T1	B07	70
SD685L	Leisure Plus	C	12	75	N/A	258	172	200	222	1	Dual post	B07	70
PAGM75-12	VRLA AGM	C	12	75	N/A	260	169	206	215	1	F11	N	100
PAGM100-12	VRLA AGM	A	12	100	N/A	328	172	222	222	1	F12	N	350

# Electrical



## Rigid high density solar panel kits Aero brackets

**STPUMH100AE : 100 W**      **STPUMH150AE : 150 W**  
**STPUMH125AE : 125 W**      **STPUMH200AE : 200 W**

- Includes everything needed to install the panel and comes complete with premium aero brackets, PWM charge controller, cable gland, elastic adhesive and user manual
- Power ratings up to 200W
- Continuous trickle feed of power to prevent battery drain
- Creates energy self-sufficiency for off-grid travel
- All PV Logic MPPT charge controllers come with free-to-download Bluetooth app, to display how the solar system is performing



## Fold up solar panels

**STFP08 : 8 W**      **STFFP120: 120 W**  
**STFFP90: 90 W**

- Quick and easy to use
- Each panel has its own integrated stand, charge controller and battery
- Just open up and connect to a battery for instant power
- 90 and 120 Watt panel includes 10A in-line PWM



## Flexi high density solar panel kits

**STPVFURT110PT: 110 W**

- The roof and deck top kit comes with all you need to install a panel. With power ratings up to 290W, our MHD solar panels fulfil a variety of energy needs ranging from a continuous trickle feed of power to prevent battery drain in caravans.
- The 10A charge controller supplied in the kit protects the battery from being overcharged and to prevent reverse current drain.



## Flexi high density solar panel - rear exit

**STPVFU290R: 290 W**

- The 290w MHD Flexi solar panel combines shingled monocrystalline solar cells to deliver super efficient power generation with a tough ETFE top sheet for longevity and robust impact resistance
- At just 2mm thick, this ultra-lightweight panel is ideal for flat roofs as well as surfaces with a slight curve making it the perfect choice for camper vans and boat decks.

*Please note, this product is the panel only, not a full kit.*

# Electrical



## Dometic T2500H 2kw petrol generator

9102900005

260 x 200 x 320 mm

- 230 V AC – just like at home
- Extra 12 V output for battery charging
- 2000 W continuous output
- 2200 W peak output
- Remote control included
- Sound-dampened stainless steel cabinet

## Dometic TEC29 2600w continuous Gnerator

9102900299

44 kg

- Petrol-fuel LED engine
- modest energy consumption
- Very quiet running
- Suitable as a power source for all dometic air conditioners
- Includes 5m extension cable and change over switch.



## Dometic AG101 15L fuel tank

9102900009

260 x 200 x 320 mm

- 15 litre, plastic fuel tank
- Weight: 2.5kg



## Dometic TEC29 generator fuel tank

9102900010

- Accessory for Dometic generators
- Comes complete with supports and integrated feed mouth for convenient filling



## Dometic AG102 changeover valve

9102900013

- Dometic AG102 change over relay to suit T2500/TEC29/TEC30

# Electrical



## CBE Water tank probes

Please note that the measurements shown on the right are the suitable tank depth's and not the length of the probe. The probe will always be shorter than the depth of the tank.

505121 : 210 mm  
505131 : 310 mm

505140 : 400 mm  
505170 : 700 mm

• For use with : PC100 , PC110, PC180 and suitable for tank depth shown above.

512012 : 120 mm  
512015 : 150 mm  
512016 : 160 mm  
512018 : 180 mm  
512020 : 200 mm  
512022 : 220 mm  
512024 : 240 mm  
512028 : 280 mm

512030 : 300 mm  
512031 : 310 mm  
512033 : 330 mm  
512036 : 360 mm  
512038 : 380 mm  
512040 : 400 mm  
512050 : 500 mm

• For use with : PC210, PC380 and suitable for tank depth shown above.

## CBE PC100 power control system

### PC100KIT

- Includes all cables & connectors
- Car battery control
- Service battery control
- Drinking water tank level control
- Car battery recharge control
- Minimum voltage device control
- Lights control
- Water pump control
- Battery parallel relay
- Protection fuses



## CBE PC110 power control system

### PC110KIT

- Includes all cables & connectors
- Car battery control
- Service battery control
- Drinking water tank level control
- Car battery recharge control
- Minimum voltage device control
- Lights control
- Water pump control
- Battery parallel relay
- Protection fuses

## CBE PC180 power control system

### PC180KIT

- Includes all cables & connectors
- Car battery control
- Service battery control
- Drinking water tank level control
- Car battery recharge control
- Minimum voltage device control
- Lights control
- Water pump control
- Battery parallel relay
- Protection fuses





# Electrical

## CBE PC210 power control system

**PC210KIT01Black**  
**PC210KIT02White**

- DS300 12V fused distribution box
- DS120s 230V AC mini consumer unit
- Double pole 13a circuit breaker & RCD
- Screw probes for waste tank level sensing
- CB-516 16A 4-stage automatic battery charger
- 230V AC junction box
- Internal and external temperature sensors
- 2.9" colour lcd display
- Wiring harnesses, connectors & terminals



## CBE PC260 power control system

**PC260KIT**

- Microprocessor controlled digital system with 3,2" GRAPHIC NEGATIVE LCD control panel.
- Test car and service battery B1 and B2 condition (volt and graphic)
- Test drinking water tank level (percentage and graphic)
- Waste water tank alarm
- Electronic battery separator
- Control 3-way fridge
- Protection fuses
- Control car battery recharging
- Save service battery function
- Digital clock
- Test internal and external temperature
- Twilight sensor



## CBE PC380 power control system

**PC380KIT01**

Water level sensor not included

- Digital control panel with 4.8" display
- Wiring harnesses, connector blocks and terminals
- DS120s 230V AC mini consumer unit with double pole 13A circuit breaker and RCD
- Screw probes for waste water tank level sensing
- 230V AC junction box.
- CB-516 16A 4-stage auto battery charger
- Internal and external temp sensors
- DS300 12V fused distribution box

**PC380KIT02**

Water level sensor not included

- LCD display panel
- Switch mode battery charger 16 amp
- 12V distribution box with 15 fuses and integrated amp meter
- Couple screws, connections and pins
- Circuit breaker 25 amp RCD, 2 x 13 amp MCB



# Electrical



**CBE NE273 power control system**

**NE273KIT**

- Microprocessor controlled digital system with 7" GRAPHIC COLOURS control panel.
- The power control system includes :
- NE273 Control Panel
- NE356 12V Distribution box
- SSP : Drinking water tank probe S1-S2
- SSR : Waste water tank probe R1-R2
- CSS : Cable kit for tank probe S1=6MT R1=6MT
- CPC : Cable for control panel L=8M
- CPT : Cable for external temperature L=4M



**CBE NE334 power control system**

**NE334KIT**

- LED TOUCH control panel with 3-digit display.
- Check in volts and graph of the car battery and service battery status.
- Percentage check and graph of fresh water tank status.
- Waste water tank reserve alarm , Integrated electronic battery separator.
- Trivalent fridge management , 13 12V user protection fuses
- Car battery recharge (maintenance).
- Under voltage control ("battery saver" function).
- Digital clock.
- Integrated internal and external temperature display opt
- Display brightness adjustment function.



**Sargents modular system with 4" screen**

**K940A**

- Provide protection and control for all AC & DC circuits
- Touch screen Control Panel with intuitive interface for control and monitoring of equipment
- Multi-stage battery charger - up to 20Amps for charging your battery
- Fresh & Waste tank sensors - tank monitoring and control panel alerts
- Environmental sensors - monitor internal/external temperature & humidity
- Plug & Play connections - Flexible and easy installation.
- Fully protected - built-in RCD, MCB and 12V fused protection



**Sargents modular system with 7" screen**

**K970A**

- Provide protection and control for all AC & DC circuits
- Touch screen Control Panel with intuitive interface for control and monitoring of equipment
- Multi-stage battery charger - up to 20Amps for charging your battery
- Fresh & Waste tank sensors - tank monitoring and control panel alerts
- Environmental sensors - monitor internal/external temperature & humidity
- Plug & Play connections - Flexible and easy installation.
- Fully protected - built-in RCD, MCB and 12V fused protection

# Electrical



## Sargent EC160 deluxe power supply unit

**EC160SV : Silver horizontal panel**

**EC160VSV : Silver vertical panel**

**EC160 : Black horizontal panel**

**EC160V : Black vertical panel**

- 16a input via wired 2m lead
- RCD protected with reverse polarity indication
- Built in 150w 13.8v fixed voltage battery charger with on/off switch
- 3 x 10a MCB outputs via quick fit connector blocks
- 2 x 15a battery inputs via screw terminal block
- 5 x outputs via screw terminal block
- Pump output via pump switch & 5a fuse

- Lights output via lights / aux switch & aux 10a fuse
- Built in split charge relay & emc isolation relay (configurable)



## Sargent battery voltage meter gauge 1 switch control panel

**EC10**

- Incorporates a clear, easy to read digital display. this is operated by
- Using the built-in on/off switch and has a range of 9 - 14.5V

## Sargent EC20 control panel

**EC20**

- Features a battery selection switch that allows you to choose the use of either the leisure or vehicle battery
- Included is 1 x 10a 12v switched output and a digital voltmeter display with on/off switch



# Electrical



Sargent EC30 control panel

## EC30

- 3 x 10a 12v switched focus outputs including pump and lights
- The battery select switch allows the use of either the leisure or vehicle batteries
- Also incorporated is a digital voltmeter display with on/off switch



Sargent AC50Z control panel

## AC50Z

- Easy to use switch design to control power, entry light, water pump, and to read the battery level
- This panel requires a separate relay to turn the leisure power on/off



Sargent EC155 and EC50 power management kit (without sensors)

## K155A

- Inside the box is:
- EC155 PSU
- EC50 control panel
- 12V & 230V wiring harnesses
- 5 metre connecting lead, for between the PSU and control panel

Sargent EC155 and EC51 complete power management kit

## K155B

- EC51 control panel
- 2 metre length control lead
- EC155 DIY 230V & 12V harness
- Waste water harness
- Fresh water harness
- Waste tank sensor
- Fresh tank sensor kit



# Electrical



## Whale 230V housing outlet

**SO3000B : Single outlet**  
**SO3005B : Double outlet**

- Whale Easi-Slide 230V single outlet housing
- Slick design - uniform look on the vehicle's exterior walls
- Comfortable to use
- Waterproof protection
- High quality satin finish UV stabilised to prevent damage from sunlight
- Electrical spec: 230V AC/13 Amp
- Weight: 0.25kg
- Electrical Connections: JST plug (LP-03-1)
- Compliance: BS1363 and IP55 rated when lid closed.
- Please note that this item is the housing only and should be purchased along with one of the Whale 230V housing lids (as shown below)



## Whale 230V housing inlet

**SO3100B**

- Whale Easi-Slide 230V single inlet housing
- Slick design - uniform look on the vehicle's exterior walls
- Comfortable to use
- Waterproof protection
- High quality satin finish UV stabilised to prevent damage from sunlight
- Electrical spec: 230V AC/16A
- Weight: 0.26kg
- Compliance: BS1363 and IP55 rated when lid closed.
- Please note that this item is the housing only and should be purchased along with one of the Whale 230V housing lids (as shown below)

**Please note : Image to the left shows housing with the white housing lid (AK1429B) which is purchased separately**



## Whale 230V housing lid

**AK1429B: White**

- Whale Easi-slide lid that simply clicks into place and adds a colour coded lid to your 12 or 230V whale easi-slide housing.



## Whale 230V housing lid

**AK1449B : Grey**

- Whale Easi-slide lid that simply clicks into place and adds a colour coded lid to your 12 or 230V whale easi-slide housing.



## Whale 230V housing lid

**AK1482B : Black**

- Whale Easi-slide lid that simply clicks into place and adds a colour coded lid to your 12 or 230V whale easi-slide housing.

# Electrical



**Fawo flush mains inlet with magnetic closing**

01746T10099 : White lid  
01746T10499 : Grey lid  
01746T10599 : Black lid

- All have grey casing
- Size:: 133 x 144 x 80 mm (W x H x D)



**Bullfinch 230V outlet**

6093/01

- Requires 105mm cutter and 4 self tapping screws
- IP55 protection against water & dirt ingress when plug inserted & lid closed
- Lightweight & compact



**Truma 230v mains outlet**

47300-51

- For 230v appliances
- External fit
- Foam black seal
- Includes four fixing screws



**Fawo 240V flush mains inlet**

01646T14799 : Grey 90 x 80 x 90 mm  
01646T15099 : White  
01646T14399 : Black

- Spring loaded magnetic closure, IP44 rating
- Flush 3 pin mains inlet box



**FAWO 230V white outlet with UK socket**

01746T31699

- Fawo 230v outlet UK socket in white with magnetic lock



**Fawo multi-function flush outlet**

01746T31899 : White  
01746T31599 : Black  
01746T31499 : Grey

- UK socket. 2 x SAT, 1 x 12V, RAL9010



**CBE PT642 12V digital test panel**

204642

- To monitor leisure batteries and solar panels



**CBE 12V digital test panel**

204652

# Electrical



**CBE battery test panel with LED**

**270542 : Grey**

- A great compact fittings to allow you to keep track of battery level
- Has a positive and negative wire that you leave permanently connected to the battery



**CBE fresh and waste water level indicator kit**

**212898 : Grey**

- Kit includes waste tank screws, fresh tank probe, control panel and cables
- Probe length 280mm



**CBE fresh water tank level kit**

**270572 : Grey**

- Kit which includes probe, control panel and cables
- Probe included



**CBE waste water tank level kit**

**270573 : Grey**

- Kit includes control panel and cables



**12v cigarette socket**

**A13-142A**

**A13-142E : Illuminated**

- Without mounting plate
- Watertight cover, sealink locking system
- Fits 21mm diameter plugs
- Panel cut-out 29mm diameter & 26.3mm d flat- 6.35mm tab terminals



**Fawo USB charger**

**01653T50699 / 01653T58799 : Single**  
**01653T49999 : Twin**

- Fawo USB charger. 12V DC/ 5V DC, 3000ma.
- Includes nut and integrated voltage transformer



**Fusebox with red light**

**R3-76-01-3L104 : 4 Fuse**

**R3-76-01-3L106 : 6 Fuse**

**R3-76-01-3L110 : 10 Fuse**

- Red indicators , 32v DC
- Maximum current 30a per circuit



**Sterling 12 way fuse holder with LED fault lights**

**FH6W : 6 Way**

**FH12W : 12 Way**

- ATC/ATO fuse holders with LED fault lights to display blown fuses clearly
- Removable clear polymer cover

# Electrical



**CBE support frames  
Grey**

270802: 1 Way (single)  
270804 : 2 Way (double)  
270882 : 3 Way (triple)

- Grey CBE support frame.
- Available in single, double or triple versions



**CBE outer frame  
Grey**

270822: 1 Way (single)  
270862 : 2 Way (double)  
270902 : 3 Way (triple)

- Grey CBE outer frame.
- Available in single, double or triple versions



**CBE outer frame  
Grey metallic**

270837: 1 Way (single)  
270877 : 2 Way (double)  
270917 : 3 Way (triple)

- Grey metallic CBE outer frame.
- Available in single, double or triple versions



**CBE outer frame  
Black metallic**

270838: 1 Way (single)  
270878 : 2 Way (double)  
270918 : 3 Way (triple)

- Black metallic CBE outer frame.
- Available in single, double or triple versions



**CBE outer frame  
Matt black**

270828: 1 Way (single)  
270868 : 2 Way (double)  
270908 : 3 Way (triple)

- Matt black CBE outer frame.
- Available in single, double or triple versions



**CBE outer frame  
Graphite**

270829: 1 Way (single)  
270869 : 2 Way (double)  
270909 : 3 Way (triple)

- Graphite CBE outer frame.
- Available in single, double or triple versions



**CBE outer frame  
Grigo aluminium**

270829: 1 Way (single)  
270869 : 2 Way (double)  
270909 : 3 Way (triple)

- Grigo aluminium CBE outer frame.
- Available in single, double or triple versions



**CBE outer frame  
Nikel flatline**

271010BS: 1 Way (single)  
271020BS : 2 Way (double)  
271030BS : 3 Way (triple)

- Nikel flatline CBE outer frame.
- Available in single, double or triple versions



**CBE outer frame  
Silver Flatline**

271010PE: 1 Way (single)  
271020PE : 2 Way (double)  
271030PE : 3 Way (triple)

- Silver flatline outer frame.
- Available in single, double or triple versions



# Electrical



**CBE presto frame**  
Grey

**002681 : 1 Way (single)**  
**002660 : 2 Way (double)**

- CBE presto outer frame in grey
- Available in single or double versions



**CBE 12V socket with waterproof cover**

**270202 : Grey**

- CBE single function socket
- Auto 12V socket
- 12V / 120W
- Waterproof cover



**CBE 12V + TV + SAT socket**

**270332 : Grey**

- CBE grey multi function socket
- Hella 12V socket
- 12V / 120W & TV & SAT



**CBE 12V socket**

**270302 : Grey**

- CBE 12V / 120W socket
- Hella 12V socket



**CBE TV socket**

**270402 : Grey**

- CBE single function socket
- TV



**CBE TV + SAT socket**

**270332 : Grey**

- CBE multi function socket
- TV & SAT



**CBE 12V (auto) socket**

**270212 : Grey**

- CBE multi function socket
- Auto 12V socket
- 12V / 120W & TV



**CBE 12V (auto) + TV + SAT socket**

**270232 : Grey**

- CBE grey multi function socket
- Auto 12V socket
- 12V / 120W & TV & SAT



**CBE 12V socket**

**270172 : Grey (without cover)**  
**270182 : Grey (with cover)**

- CBE single function socket
- Auto 12V / 120W socket
- Available with or without cover

# Electrical



**CBE USB A charger socket**

**270642 : Grey (single)**  
**270652 : Grey (double)**

- CBE USB charger sockets
- USB type A sockets
- Available in single or double versions



**CBE USB C charger socket**

**270662 : Grey**

- CBE USB charger sockets
- USB type C sockets



**CBE electronic dimmer switch with LED**

**270502 : Grey**

- CBE electronic dimmer with LED
- Designed for use on 12v lighting
- Maximum power 32w
- Complete with signalling LED – on/off switch and regulation knob



**Fawo British std. socket-Black 250V/13A**

**01753T02220**

- Fawo British standard socket
- Black in colour
- 250v/13a 2 poles+e. depth of 20mm



**CBE 230v 13a mains plug socket**

**002679A : Grey**

- Mains 240v UK 3 pin plug socket for use with the CBE modular switch and socket system
- You will need to also purchase a back protection box if required



**CBE Fuse socket**

**270492 : Grey**

- CBE fuse socket
- Include 1 x 15amp – 2 x 10amp & 1 x 20am



**CBE 2 position switch**

**272062 : Grey single switch**  
**272082 : Grey double switch**

- Contains a two-way, single-pole switch that can be wired in either on/off or on/on
- Available in single or double versions



**CBE single switch with LED**

**272052 : Grey**

- Single unipolar switch with LED for use with the CBE modular switch and socket system
- Consists of a one-way switch and an amber LED to indicate when the circuit is powered



**CBE step and light switch with 5 contacts**

**272112 : Grey**

- 3 position step switch and two-way 12v/240v light switch combination in grey
- 5 contacts

# Electrical



**CBE step and light switch with 4 contacts**

**272102 : Grey**

- CBE step and light switch grey 4 contacts



**CBE 12V and pump switch**

**200289**

- CBE multi switch module
- 12V and pump switches



**CBE 12V and pump switch with LED**

**200288 : Grey**

- This modular CBE double switch is suitable for isolating a 12v water pump on a motorhome or caravan



**CBE pump and light switch**

**270482 : Grey**

- CBE multi switch module
- Pump and light switch



**CBE Single 3 position switch**

**270292 : Grey**

- CBE 3 position switch module
- Single switch



**CBE Single 3 position step switch**

**270272 : Grey**

- CBE 3 position step switch module
- Single switch



**CBE 1 gang 2 way switch**

**270152 : Grey**

- CBE1 gang 2-way switch

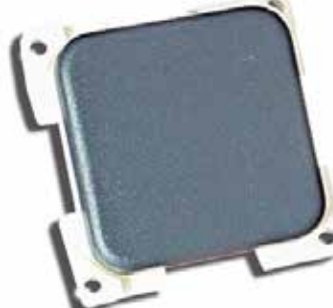

**CBE push button dimmer switch**

**270161 : Grey**

- CBE single momentary flat switch



**CBE switch**

**270122 : Grey single switch**  
**270142 : Grey double switch**

- Contains on / off single pole switch
- Available in single or double versions

# Electrical



**CBE Single unipolar + LED switch**

**270132 : Grey**

- CBE single flat switch with LED



**CBE 230V schuko socket**

**002690 : Black**

- 6a Schuko type 230 - 250v socket black
- Fixing pitch on socket is 46mm
- Cutouts required, approx 50mm
- Minimum clearance required behind front of mounting surface is 35mm



**CBE 34mm back protection box**

**002677**

- For the rear of your 230v CBE 3 pin socket, to protect wiring
- 34mm diameter



**CBE 45mm back protection box**

**002676**

- For the rear of your 230v CBE 3 pin socket, to protect wiring
- 45mm diameter



**CBE Blanking Plate**

**007150 : Grey**

- Blanking plate for use with the CBE modular switch and socket system



**CBE flap for continental box**

**002668 : Grey**

- CBE grey flap and surround for a continental box

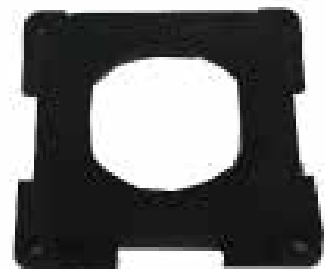

**CBE Blank plate with cutout**

**007150UD : Grey**

- CBE USB charger sockets
- USB type C sockets

# Electrical



Brackets for USB and power sockets

*JH-RS-0200 : Single      JH-RS-0500 : Double      JH-RS-0800 : Triple*

- Screw mount fixing plate for single, double or triple
- Hole centres 25mm & 133mm



Waterproof 12V socket

*A13-142A : Standard  
A13-142E : With light*



Twin illuminated USB with flap

*A13-194B-BB3*



3.1A Twin USB with flap

*JH-RS-2013*



Twin USB fast charge with flap

*JH-DS2013H*



12V Voltmeter red

*JH-DS4010*



12V Voltmeter blue

*JH-DS4010-B*



12V Voltmeter full colour

*JH-DS4010-A*



Kill switch with key 150A

*A23-7B*



Twin USB fast charge with flap

*JH-DS2013H*



12v Red illuminated switch

*R13-112B2R12*

# Electrical



Hispec pop-up tower socket

## HSTS3/USB

- Isolator switch with neon indicator
- IP20 rating
- Cutout: 80mm
- Height (above surface): 312mm
- Height (below surface): 400mm
- Cable length: 1.5m
- Amps: 5 / Max current amps: 15
- USB: 5v 2.1 amps



Sterling battery terminals Pack

## BT69PN

- Sterling battery terminals pack
- 1 pack contains 2 terminals



W4 Quick fit Battery Clamps

## 00145

- A pair (1 x positive, 1 x negative) of quick to fit and quick to release battery clamps
- Size: 1 x 4.9 x 6.7 cm



Liberty Leisure Cordwheel

## LL1555

- Easy to use, lightweight cordwheel for use with any cable/cord.
- Large enough for a 25M mains cable to be wound around it.
- Please note cable shown in the image above is not included, this is the cordwheel only.

# Electrical



## Quest 230V mains leads

**E0037A : 10M**

**E0038A : 25M**

- Caravan / motorhome / camping mains site lead allowing you to hook up your caravan, motorhome, tent or more to site electrics.
- Made from the higher specification 2.5mm core to ensure your safety and help cut out electrical issues and fully IP44 rated for outdoor use. Durable and easy to use.
- Has 1 x 3 pin (male) earthed plug on one end, then 25mm orange, outdoor quality cable and a 3 pin (female) earthed socket with weather cover on the other.
- 3 Pin (male) earthed socket one end
- 3 pin (female) earthed socket with weather cover on one end



## Quest surface mounted mains inlet

**E0032**

- High Quality, Durable, Easy to use
- 3-Pin (male) earthed plug



## Quest site mains 230V UK trailing socket

**E0036**

- High Quality, Durable, Easy to use
- 3-Pin (male) earthed socket
- Standard UK plug socket



## Quest UK hook up lead adaptor

**E0034**

- High Quality, Durable, Easy to use
- 3-Pin (female) socket with weather cover
- Standard UK 3 pin plug



## Quest Euro hook up lead adaptor

**E0035**

- High Quality, Durable, Easy to use
- 3-Pin (female) socket with weather cover
- Standard Euro 3 pin plug

# Gas



Truma VK4 4 way manifold gas valve

**24155-31DVP** 8 mm  
**24156-31DVP** 10 mm

- 4 way manifold gas valve
- Brass olives and steel nuts
- Over-lock turning tap head



Truma VK3 3 way manifold gas valve

**24135-31DVP** 8 mm  
**24136-31DVP** 10 mm

- 3 way manifold gas valve
- Brass olives and steel nuts
- Over-lock turning tap head



Truma VK2 2 way manifold gas valve

**24115-31DVP** 8 mm  
**24116-31DVP** 10 mm

- 2 way manifold gas valve
- Brass olives and steel nuts
- Over-lock turning tap head



K4-8mm DVP manifold valve

**23112-31DVP**

- Straight, quick-acting valve
- Both ends 8mm screw fitting
- Brass olives and steel nuts

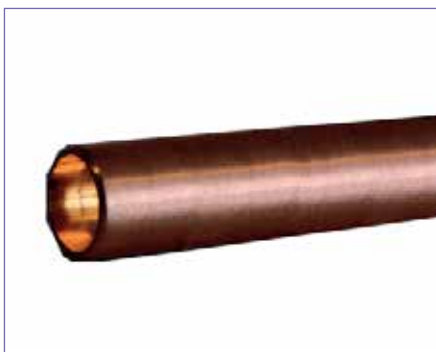

30m Copper gas pipe

**M30M/8MM**

- Suitable for 8mm gas fittings



Straight union for gas pipe

**MC108 : 8mm Brass**

- In-line configuration
- Connection of 2 pipes of the same diameter



Elbow union for gas pipe

**ME108 : 8mm Brass**

- Connection of 2 pipes of the same diameter



T union for gas pipe

**MT108 : 8mm Brass**

- Connection of 3 pipes of the same diameter



GOK BBQ coupling valve

**2100000**

- Consists of valve 2131502 & 0245225



# Gas



**Cavagna gas regulator 30mbar side outlet**

**42.1.490.1074**

- Built-in over-pressure protection
- Two stage, low pressure LPG regulator
- Suitable with propane or butane gas
- Inlet: w20. outlet: 8mm compression
- Max inlet pressure: 20 bar



**Caravan 90° regulator 30mbar**

**42.1.490.1076**

- Use with propane or butane gas
- Built-in over-pressure protection
- Inlet: w20. outlet: 8mm compression



**Cavagna camping gaz regulator**

**79.1.490.2701**

- Max inlet pressure: 6 bar
- Operating pressure: 29 mbar
- Capacity kg/hr: 0.8
- Inlet: 16 x 1.5, Outlet: 8mm nozzle



**GOK regulator**

**0129471**  
**0129476**

8 mm  
10 mm

- Bulkhead mounted gas regulator
- With integrated test point & elbow
- Operates at 30mbar and 1.5kg/hr
- Does not include pressure gauge



**Clip on regulator - 28mbar - 21mm**

**63.1.490.5112**

- With reinforced diaphragm
- 1kg/h -21mm inlet
- 8mm outlet



**Butane regulator RD 28mbar**

**69.1.490.2028**

- Max inlet pressure: 20 bar
- Operating pressure: 37 mbar
- Capacity kg/hr: 1



**Propane regulator, 37mbar**

**69.1.490.2029**

- Max inlet pressure: 20 bar
- Operating pressure: 37 mbar
- Capacity kg/hr: 1



**Propane Reg, 37mbar**

**69.1.490.2263**

- Operating pressure: 37MBAR
- Capacity KG/HR: 1.5
- Inlet: POL 105 soft nozzle
- Outlet: 8MM nozzle
- Pre 2005 vans



**21mm Clip on Adaptor**

**51.1.190.5018**

- Easy to use
- Simply clips on
- 21mm butane clip on adaptor

# Gas



## Truma 30mbar gas regulator Retail boxed

### 52400-01 : Retail

- Works on either propane or butane
- Inlet pressure 0.3-16 bar, Outlet 30 mbar
- Regulator inlet male thread m20 x 1.5 (g.13) \* bulkhead fitting and suitable for 8 or 10mm gas system

## Truma mono control CS - 30mbar 10mm elbow OEM

### 52411-64 : OEM

- With crash control sensor, pigtail on inlet and connection outlet to copper / steel pipe of vehicle
- Automatic shut off of the gas system in an accident
- Outlet pressure 30 mbar

## Truma mono control CS 10mm

### 52412-64 : OEM

- Crash sensor
- Output: 1.5 kg/h
- 10mm inlet

## Truma mono control CS 30mbar vertical or horizontal regulator

### 52412-01 : Retail

- Energy sources: propane / butane
- Inlet pressure: 0.3 – 16 bar
- Regulator output/flow rate: max. 1.5 kg/h
- Regulator inlet: male thread m20 x 1.5 (g.13)
- Olive screw connection 8 mm or 10 mm (h. 9)
- Crash sensor triggering value: 4.0 g +/- 1.0 g
- Operating temperature range: -20 °c to +50 °c

## Truma new style gas regulator

### 52400-51 : 8mm : OEM

### 52400-52 : 10mm : OEM

- Flow rate 1.5 kg/h
- Inlet pressure 0.3 to 16 bar
- Outlet pressure 30 mbar
- Inlet connection M20
- Outlet connection 10mm
- Fuel LPG



## Truma duo control CS 30mbar vertical gas regulator

### 51611-01 : Retail

- Can be reset by pressing the yellow button
- Regulator inlet m20x1.5 (g.5)
- Regulator outlet olive screw connection 10/8mm.
- Regulator capacity 1.5kg/h
- Must be used with rupture protection hose



## Truma duo control CS 8/10mm horizontal gas regulator

### 51621-01 : Retail

- Crash sensor for two cylinder operation
- Shows which cylinder is in use and whether it is full or empty
- Automatically switches over from the empty cylinder to the full one

# Gas



1.5m x 6.3mm pigtail black handwheel S/T POL x W20 class 3 Propane

**LPGA-MI-PT1150HXXW20**

- 1150mm x 6.3mm propane gas tube with pigtail end and handwheel, Black in colour

750mm pigtail black c/w handwheel class 3 Propane

**LPGA-MI-PT750HXXW20**

- Complete with handwheel loose, 750mm x 6.3mm

Single 450mm pigtail black handwheel class 3 Propane

**LPGA-MI-PT450HXXW20**

- 450 x 6.3mm propane gas hose with pigtail end and hand wheel, Black in colour



Single pigtail black class 3 Propane

**LPGA-MI-PT450PXW20** 450 x 6.3 mm  
**LPGA-MI-PT750PXW20** 750 x 6.3 mm  
**LPGA-MI-PT15000PXW20** 1500 x 6.3 mm

- For use with propane
- Available in three different lengths



Single pigtail black class 3 Butane

**LPGA-MI-PT450BXW20** 450 x 6.3 mm  
**LPGA-MI-PT750BXW20** 750 x 6.3 mm

- For use with butane
- Available in two different lengths



HP Pigtail hose 450mm GB Propane

**50415-12**

- Rupture protection for use with the Truma monocontrol CS and the duocontrol CS
- This system is compulsory when using drive safe systems and automatically cuts the gas supply in the event of an accident



Truma GB pigtail 450mm Propane

**50405-12**  
**50405-12PK : Retail**

- Rupture protection for use with Truma monocontrol CS and duocontrol CS



High pressure hose 750mm propane

**50425-02**

- Gas outlet socket for connecting a BBQ outside, used in caravans, motorhomes and campervans



50m x 8mm Orange BS3212/2

**LPGA-MI-BS3212/2-8**

- 50m x 8mm Orange BS3212/2 hose
- Without reel

# Gas



GOK 90 degree regulator elbow

**1150900**

- GOK 90 degree regulator elbow for all Truma regulators.
- Safer connection without having to use a union or t-pieces



Camping Gaz adapter

**0973705 : GOK**

- Works in combination with the butane pigtail in modern gas installations to allow for smaller Camping Gaz bottles



Camping Gaz adapter

**1577 : Cavagna**

- Works in combination with the butane pigtail in modern gas installations to allow for smaller Camping Gaz bottles



Fawo gas bottle bracket spacer  
Black plastic

**01656T03189**



DLS Gas bottle holder spacer

**5012050**

- 30mm gas bottle holder spacer in black



DLS Gas bottle base holder  
light grey

**6056441**

250 X 250 mm

- Suits BP gas light and comparable steel bottles
- Base holder for 6 kg and 7 kg LPG bottles



Gas bottle box for 907  
Camping Gaz bottles

**GBB907 : Standard**  
**GBB907DL : Deluxe**



Gas bottle brackets (black)

**6059050 : DLS (flexible)**  
**01656T03089 : Fawo (non-flexible)**



Gas bottle straps (black)

**6043050 : DLS**  
**01656T03299 : Fawo**

- DLS : 1250 mm
- Fawo : 1200 mm

# Gas



Fawo gas socket housing only with magnetic lock

01746T59099

- Requires valve 2100000



Truma gas remote switch

57014-01

- Shuts off the entire gas supply by the touch of a button



Bullfinch gas point

6087/01 : White      6087/08 : Black  
6087/05 : Grey

- With plug in tail connector & fixing screws.
- Push & turn activation, includes 6087d connector, Innovative, attractive design



FAWO BBQ point with magnetic locking

01746T50199: White  
01746T50599: Black

- Rounded base allows for quicker fitting
- Fitted with a hinged lid and magnetic locking
- Complete with integrated black foam seal



Truma BBQ point

23291-01 : White      145 x 105 mm  
23291-03 : Black

- BBQ quick release external gas point.
- Easy and simple one-handed operation.
- LPG compatible, complete with adapter.



## Whale Easi Slide BBQ Socket and lids

SO1000B : BBQ Socket

AK1427B : Lid (White)

AK1447B: Lid (Grey)

AK1480B: lid (Black)

### Easi Slide BBQ Socket

- Working Pressures: 4 bar max, 30mBar nominal working pressure.
- Gas connections: M14 x 1.5 threaded nut and compression olive for use with 8mm diameter gas pipe.
- Height: Closed: 270mm / Open: 164 mm , Width: 103 mm , Weight: 0.39kg

### Easi Slide Lid

- The Whale Easi-Slide BBQ gas socket lid is used in conjunction with the Easi-Slide BBQ socket.
- The lid simply click into place and then slides over the socket to form a colour coded cover adding weather protection to your socket.

# Cleaning & Sanitation



**Thetford C220CS (C223CS)  
Cassette Toilet**

**200851 : OEM**

534 x 394 x 580 mm

**200868SP : Retail**

- Electric flush
- Waste level indicator
- Splash guard
- Swivel seat
- Connects directly to cold water
- stream
- Easy roll wheels
- 18L waste tank
- 7.2KG



**Thetford C220CW  
(C224CW)  
Cassette Toilet**

**200856 : OEM**

**200869SP : Retail**

727 x 394 x 580 mm

- Manual flush
- Waste level indicator
- Splash guard
- Swivel seat
- Easy roll wheels
- Self contained flush tank
- 18L waste tank
- 9L Flush tank



**Thetford C220S (C223S)  
Cassette Toilet**

**200850 : OEM**

495 x 365 x 580 mm

- Durable plastic
- Electric flush
- Efficient performance
- High level of comfort
- Central water tank connection
- 18L waste tank



**Thetford C200S CS  
Cassette Toilet**

**23334**

- Flush: electric (12v)
- Integrated pour-out-spout
- Connects to vehicle's central water tank
- 17L waste tank



**Thetford C262CWE  
Cassette Toilet**

**93367SP : Standard bowl**

**93388SP : Ceramic bowl**

847 x 417 x 603 mm

- Handle for emptying
- Easy roll wheels
- 17.5L waste tank
- 8L flush tank
- Electric flush
- Waste level indicator
- Splash guard
- 90° rotating bowl

# Cleaning & Sanitation

	<b>Thetford C263S Cassette Toilet</b>
	<b>93301 : Standard bowl</b> <span style="float: right;">488 x 341 x 603 mm</span>
	<ul style="list-style-type: none"> <li>Removable waste tank</li> <li>External flush controller</li> <li>90° rotating bowl</li> <li>Pull out handle</li> <li>Uses flushing water from an on-board water tank</li> <li>Integrated wheels</li> <li>Built in toilet</li> <li>Central water tank connection</li> <li>17.5L waste tank</li> <li>Weight: 7.1 kg</li> </ul>

	<b>Thetford C263-S Ceramic bowl Cassette Toilet</b>
	<b>93386SP</b> <span style="float: right;">511 x 341 x 600 mm</span>
	<ul style="list-style-type: none"> <li>3 level indicators</li> <li>Electric flush system</li> <li>Removable waste tank</li> <li>Connects to central water tank</li> <li>Weight: 16.2 kg</li> <li>17.5L waste tank</li> </ul>

	<b>Thetford C263CS Cassette Toilet</b>
	<b>93385SP : Standard bowl 93387SP : Ceramic bowl</b> <span style="float: right;">750 x 417 x 603 mm</span>
	<ul style="list-style-type: none"> <li>Integrated wheels</li> <li>Pull out handle</li> <li>90° rotating bowl</li> <li>Removable waste tank</li> <li>Central water tank connection</li> <li>Built in rear mounted flush controller</li> <li>17.5L waste tank</li> </ul>

 <div style="position: absolute; top: 10px; right: 10px; background-color: #4CAF50; color: white; border-radius: 50%; padding: 5px; text-align: center; width: 40px; height: 40px; display: flex; flex-direction: column; justify-content: center; align-items: center;"> <span style="font-size: 8px; line-height: 1;">LEFT HAND PART PICTURED</span> </div>	<b>Thetford C403L Cassette Toilet</b>	<b>Thetford C402C Cassette Toilet</b>
	<b>51708 : Left hand 51701 : Right hand 51679SP : Left hand (retail) 51678SP : Right hand (retail)</b> <span style="float: right;">512 x 670 x 400 mm</span>	<b>51695 : Left hand 51698 : Right hand</b> <span style="float: right;">512 x 670 x 400 mm</span>
	<ul style="list-style-type: none"> <li>Durable plastic</li> <li>Electric flush</li> <li>Green accent colour</li> <li>High level of comfort</li> <li>Plumb directly into water system</li> <li>19.3L waste tank</li> </ul>	<ul style="list-style-type: none"> <li>LED level indicator</li> <li>Electric push button</li> <li>Rotating spout</li> <li>Automatic pressure release vent</li> <li>19.3L waste tank</li> <li>15L flush tank</li> </ul>

# Cleaning & Sanitation



## Thetford Porta Potti 565E / 565P Portable Toilet

**92306E : Electric Flush (565E)**

488 x 388 x 450 mm

**92305 : Piston pump flush (565P)**

- Waste level indicator
- Flush level indicator
- Integrated toilet paper holder
- Electric or piston pump flush
- Electric uses 6 x 1.5v AA batteries
- Weight (piston) : 5.8 kg
- Weight (electric) : 5 kg
- 21L flush water tank
- 15L waste tank



## Thetford Porta Potti 145 Portable Toilet

**92802**

330 x 383 x 427 mm

- Doesn't require a connection to a drainage or water system
- Choice of flushing system
- Bellow pump
- Weight: 3.6 kg
- 15L flush tank
- 12L waste tank



## Thetford Porta Potti 165 Portable Toilet

**92806**

330 x 383 x 427 mm

- Doesn't require a connection to a drainage or water system
- Choice of flushing system
- Bellow pump
- Weight: 3.8 kg
- 21L flush tank
- 15L waste tank



## Thetford Porta Potti 335 / 345 / 365 Portable Toilet

**92828 : 335**

313 x 342 x 382 mm

**92814 : 345**

330 x 383 x 427 mm

**92820 : 365**

414 x 383 x 427 mm

- Durable plastic
- Piston pump flushing system
- Waste level indicator
- Easy and convenient emptying

### 335 Details

- 3.3 kg
- 10L Flush water tank | 10L Waste tank

### 345 Details

- 3.8 kg
- 15L Flush water tank | 12L Waste tank

### 365 Details

- 4 kg
- 15L Flush water tank | 21L Waste tank



# Cleaning & Sanitation



## Dometic 972B Portable Toilet

**9108557679**

317 x 333 x 387 mm

- Space saving with a 9.8 l waste holding tank
- Weight 4.68 kg
- Portable so you can take it anywhere
- Less mess due to an extra-long, pivoting discharge spout
- Less pump with a push button operation
- Less splash as the tank level indicator protects against overflow
- Home comforts of an adult-sized seat



## Thetford Service Doors

### 21100784SP : Light grey

- Door 3
- Comes with lock and two keys

### 21100780SP : White

- Door 3
- 1 x lock button
- 1 x push button
- Daylight opening 330 x 280 mm
- Comes with lock and two keys

### 2680580 : White

### 2680584 : Light Grey

### 2680527 : Black

- Door 3
- 1 x lock button
- 1 x push button
- Comes with lock and two keys
- Complete door kit including frame
- Comes with cutting template

### 21100280SP : White

- Door 3
- Without lock or keys
- Comes with 1 push button and door inner

### 21100280 : OEM White

- Door 3
- 1 x lock button
- 1 x push button
- Daylight opening 330 x 280 mm
- Frame inner not included
- Without lock or keys

### 2680727SP : Black

- Door 3
- 385 x 335 mm
- 1 x push button
- Compact size service door
- Without lock or keys
- Oem packed
- Door opening h x w : 330 x 280



## Thetford WaterFill Door

**2354280 : OEM**

158 x 134 mm

- Comes with zadi lock and 2 keys
- Cut out: 130 x 100 mm
- Vehicle wall thickness: 23 - 29 mm
- Net weight 0.3kg

## DATA FEEDS

Did you know we can send you a data feed with as much (or as little) stock details on, allowing you to automatically update your website, Amazon, Ebay or anything else !

# Furniture & Fixings



Aluminium profile- open ended

**EVO/ALU17 : Silver 17 mm**  
**EVO/ALU40 : Silver 40 mm**  
**EVO/ALU17BLACK : Black 17 mm**  
**EVO/ALU40BLACK : Black 40 mm**

- For use with 15mm board to add curved edges to your units and furniture, 2.5M length
- Order in 6's for 17mm and 8's for 40 mm



Plastic strip for aluminium profile

**EVO/ALUTRIM**

- Plastic strip for a aluminium profile
- Comes in 2.5M lengths



40mm Aluminium shelf profile open one side

**AP-SH-26--BLACK : Order in 3's**  
**AP-SH-26--SILVER : Order in 3's**

- Total length: 2600 mm, Wastage : 100 mm
- Usable length : 2500 mm
- For use with 15mm board



Evo Locker catch Satin Chrome with black centre

**EVO/SCB1 : Order in 20's**  
**EVO/SCB1PK : 5 Pack**

- Works with panel thickness: 12-18mm
- Can be opened from front and back
- Self locking door catch designed for leisure vehicles



EVO Locker catch in black

**EVO/BB1 : Order in 20's**  
**EVO/BB1PK : 5 Pack**

- Works with panel thickness: 12-18mm
- Can be opened from front and back
- Self locking door catch designed for leisure vehicles



Hafele 15 mm small push button

**229.01.211 : Chrome : Order in 100's**  
**229.01.211PK : Chrome : 10 pack**  
**229.07.606 : Nickel : Order in 100's**  
**229.07.606PK : Nickel : 10 pack**

- Diameter : 15 mm



Hafele 25mm small rossette

**229.03.241 : Chrome : Order in 100's**  
**229.03.241PK : Chrome : 10 pack**  
**229.09.600 : Nickel : Order in 100's**  
**229.09.600PK : Nickel : 10 pack**

- Diameter : 25 mm



Hafele matt nickel 13mm push button including rossette

**229.01.604 : Order in 100's**  
**229.01.604PK : 10 Pack**

- Diameter : 40 mm



Hafele pale nickel push button including rossette

**229.01.613 : 35 mm : Order in 100's**  
**229.01.613PK : 35 mm : 10 pack**

- Diameter : 35 mm

# Furniture & Fixings



## Hafele mini lock cases

**211.61.106 : Brown : (100's)**

**211.61.106PK : Brown : 10 Pack**

**211.61.300 : Black : (100's)**

**211.61.300PK : Black : 10 Pack**

**211.61.604 : Pale Nickel : (100's)**

**211.61.604PK : Pale Nickel : 10 Pack**

**211.61.704 : White : (100's)**

**211.61.704PK : White : 10 Pack**

- Mounting: unhande
- Backset: 15 mm
- Push-button locking & Screw fixing
- Suitable for 16 mm board thickness
- Available in 100's or packs of 10 (separate codes above)

## Hafele striking plate 40 x 10mm

**239.41.013 : (100's)**

**239.41.013PK : 10 Pack**

- Screw fixing.
- For one door closing
- Ideal strike plate for cam locks
- Finish: nickel plated
- Available in 100's or packs of 10 (separate codes above)



## Hafele lock case for push lock

**211.63.102 : Brown : (100's)**

**211.63.102PK : Brown : 10 pack**

**211.63.642 : Matt Nickel : (100's)**

- Hafele lock case for push locks
- Available in 100's or packs of 10 (separate codes above)

## Fawo lock case brown with rod aperture

**01595T50491 : 10 Pack**

- Push lock with rod aperture
- Sizes:
  - 80 mm including screw holes
  - 65 mm main body
  - 50 mm x 40 mm
- Minimum hole size required is approx 24 mm

# Furniture & Fixings



Fawo T-Lock  
Silver

**01598T25099 : 1 Point**  
**01598T20099 : 3 Point**

- Without rod aperture
- For L&R hand use for square shaft 7mm
- Size 80 mm including screw holes



Fawo 790mm nickel rod for  
T-Lock

**01598T32636**

- For use with the Fawo bathroom door t-lock



Fawo T-Lock additional catch

**01598T21099**

- With 3 point lock and lock rod



Fawo door knob with square  
shaft

**01598T70899**

- Plastic door knob with square shaft, securing screw and guide



Fawo T-Lock handle rosette  
Silver

**01598T73099**

- Width 50mm approx across front
- 11mm shaft hole size
- Length 30mm approx



Fawo F-lock handle  
Silver sand

**01598T72299**

- For square shaft
- Length 126 mm



Fawo T-Lock handle  
Silver

**01598T72099**

- For square shaft
- Length 126 mm



Fawo T-Lock 90mm square  
inner rod for handle

**01598T79099**



Fawo F-lock mechanism  
Black

**01598T80099**

- 19mm thickness door
- Left hand and right hand

# Furniture & Fixings



Fawo inner bathroom lock

**01598T71999**

- Stainless steel
- High-quality interior metal handle
- Diameter: 50 mm



Fawo bathroom door lock

**01598T95299**

- Sickle form, brushed steel surface
- 2 handles, rosettes and square rod
- Rod width: 8mm



Fawo M-Lock mechanism

**01598T88599**



Fawo M-Lock striking plate

**01598T88999**



W4 Zadi barrel lock and keys

**59000**

- Zadi barrel lock and keys
- Kit comes with 2 keys.
- Length: 34mm, Diameter is 13mm



Fawo Catch

**01595T01299 : Order in 10's**

- 10 Pack



Fawo T-Bar door retainer 2 part grey plastic

**01513T00799**

- Male part 60 mm long with hole centres 46 mm
- Female part 45 mm long with hole centres 30 mm



Fawo plastic locker stay

**01606T04088**



Fawo 170mm zinc coated locker stay

**01606T07099**

170 mm

- Telescopic with angled and side fixing

# Furniture & Fixings



Hafele cranked flush hinge

**351.95.940 : Order in 100's**  
**351.95.940PK : 10 Pack**

- Cranked flush hinge
- 5cm length
- Hole centres 41mm



Fawo furniture hinge black

**01601T05043**

- Cupboard door hinge
- Powder coated with holes for fixing
- To suit 15mm doors or cupboards



Fawo hinge  
Mid Grey

**01601T20399PK : Mid grey (LH)**  
**01601T20499PK : Mid grey (RH)**

- Powder coated steel
- 10 Pack



Fawo hinge  
(order multiples of 50)

**01601T20333 : Dark Grey (LH)**  
**01601T20433 : Dark Grey (RH)**  
**01601T20399 : Mid Grey (LH)**  
**01601T20499 : Mid Grey (RH)**  
**01601T20387 : Light Grey (LH)**  
**01601T20487 : Light Grey (RH)**



Fawo furniture fixing 4 hole

**01600T10291 : Dark Brown (100's)**  
**01600T10278 : Dark Grey (100's)**  
**01600T10287 : Light Grey (100's)**  
**01600T10291PK : Dark brown (10's)**  
**01600T10278PK : Dark grey (10's)**  
**01600T10287PK : Light grey (10's)**



Fawo furniture fixing 2 hole  
(order in multiples of 100)

**01600T11287 : Light grey**  
**01600T11281 : Black**

- Comes with cover



Fawo knock down fitting

**01600T15291PK : Order in 10's**



Fawo magazine rack in grey

**01529T01087**

- Size: 316 x 215 mm
- Ideal for securing magazines, postcards, photos and toys.



Fawo utility rack kit

**01529T20099**

- Fawo utility rack kit/clamping system. consisting of a 2m long black rubber round cord, including a patent connector and 6 retaining rings (silver) with screw covers and user manual.

# Furniture & Fixings



Fawo 60mm diameter floor vent

01539T21690 : 40 mm long  
01539T21890 : 55 mm long



Fawo Plastic floor vent Natural

01539T25099

- Tube length: 50mm
- Outer width :30mm



DLS 75mm round short tail vent

7080000 : Beige      7080441 : Grey  
7080050 : Black

- Screw holes: 65 mm
- Tail outside diameter: 55 mm / Length: 10 mm
- Free flow area is 730 sqmm

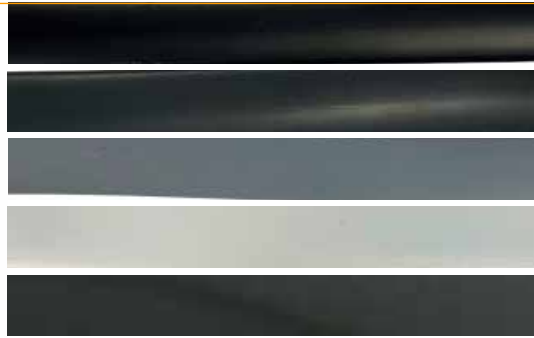

Black

Light Grey

Matt Grey

Silver

Aluminium

NEY 16mm Double lipped T trim  
(order in rolls of 100 m)

NERO/Black : Black  
GR/03 : Light Grey

GR/01 : Matt Grey  
GR/09 : Silver

AL/06 : Aluminium

- Comes in rolls of 100 m
- Plastic double lipped t trim extrusion

- Suitable for edging 15 mm furniture board
- Available in 5 different colours/finishes



Tambour doors or roller shutters are a great alternative to conventional doors in campervans. tambour doors are the perfect storage solution for van conversions when space is tight. They are light and versatile doors that can be fitted to cabinet openings either horizontally or vertically. Tambour doors are easy to fit and the height or size of the door can be reduced simply by removing slats.

**MADE IN THE UK , VERTICAL OR HORIZONTAL FITTING**

## Tambour door set

Model	Size (mm)	Colour
T5-350S	500 x 650	Silver
T5-350PB	500 x 350	Piano Black
T5-500S	500 x 650	Silver
T5-500PB	500 x 650	Piano Black
T5-650S	650 x 650	Silver

# Furniture & Fixings



Fawo 700mm island table leg  
Chrome

**01610T08037**

- 700 mm length chrome steel tube
- Suitable for use with either base 01610T08201 or 01610T08101



Fawo recessed table leg base

**01610T08201**

- Polished alloy, 60mm diameter, for use with Fawo island table leg 01610T08037



Fawo conical table leg base  
Chrome

**01610T08101**

- Polished alloy
- For use with Fawo island table leg 01610T08037



Fawo top folding table leg

**01610T50539 : 715 mm**  
**01610T50339 : 645 mm**  
**01610T51639 : 740 mm**  
**01610T51039 : 700 mm**

- Grey, trigger action fold mechanism



Fawo telescopic table Support

**01566T45699**

- Telescopic table leg
- Anodised - 549 mm



Fawo telescopic table support  
hinge - anodised

**01566T49099**

- Hinge for use with the Fawo telescopic table support (01566T45699)



Fawo Primero comfort HVK  
table leg (Silver-grey)

**01611T72099**

- Very comfortable and user-friendly!
- Height adjustable, sliding table top, fixed small base. high stability.
- Height: 345 to 705 mm, swing: 360 mm, weight: 10.9kg



Fawo Primero comfort HPK  
table Leg

**01611T70099**

- The optimized lift-technic offers maximum stability and longevity
- Can be moved down by pulling the handle
- Height: 300 - 660mm, swing: 360mm, weight: 7,7kg



Fawo centre folding table leg

**01610T54039 : 715/355 mm**

- Fawo's bi-folding centre table leg, total height



# Furniture & Fixings



\* Table and leg not included in the kit

## Fawo table rail kit kits

### TRK500 : Fawo table rail kit kits (500 mm)

### TRK950 : Fawo table rail kit kits (950 mm)

- Easy and stable fixing of the slide rail – one at the height of the table, the other at the height of the bed. Rounded end caps enclose the entire profile. Stable and easy-to-use table mount, By pressing the button from above the table can easily be moved from the left to the right. In the mid position the fixing device catches automatically.
- Kit consists of two locking brackets and two rails (lengths above)



### Surejust cranked aluminium table Leg

#### MIR8

- Swivel table stand for wall mounting
- Length: 715 mm
- Diameter: 40 mm



### Surejust aluminium clamp

#### MIR9

- Sure just aluminium clamp to be used with MIR8 - cranked table leg
- Dimensions: 130 x 93 x 60mm



### Surejust plastic bung

#### MIR6

- For recessed floor base and table leg



### Surejust stainless steel table leg

#### MIR4

- Length: 710 mm

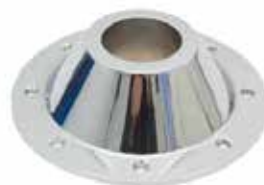

### Surejust base

- MIR1 : Above floor
- MIR2 : Recessed
- MIR3 : Small base

- - Floor base base to be used with table leg



### Surejust steel leg clip

#### MIR7

- Steel leg clip for storing table leg

# Furniture & Fixings



Redwood leg system

**CWREDS-B : Black**

- Diameter: 508 mm
- Length: 685.8 mm (27 inch)
- Aluminium floor base with plastic bung
- Plastic table bracket



Redwood leg system

**CWREDS-S : Silver**

- Diameter: 508 mm
- Length: 685.8 mm (27 inch)
- Aluminium floor base with plastic bung
- Plastic table bracket



Sequoia 3 Ali base table leg system

**CWSEQA-V3-ALI**

- Comes with: aluminium leg
- Diameter: 508 mm
- Length: 685.8 mm



Sequoia 27" table Leg

**TL4002C-27**

- Spare table leg for the sequoia table leg system



Sequoia 3 aluminium floor base

**TR4004C-P**

- Spare floor base for the sequoia table leg system



Sequoia table connector Black

**TS4000B**

- Spare table top connector for the sequoia table leg system



Sequoia floor base cap

**TC400B**

- For use with the TR4004C-P aluminium floor base



Sequoia table leg storage bracket

**CWT-VSK-B : Black**  
**CWT-VSK-G : Grey**



Reimo swivel table frame made of aluminium

**57039**

- Aluminium tube with 40 mm diameter

# Furniture & Fixings



Lippert folding table legs

**15390 : Height adjustable**  
**15370 : 720mm height**

- Folding table leg
- Adjustable leg height 555mm - 765mm
- Fixed leg height: 720 mm



Fold out table support

**1XZ0388**

- Black fold out table support



Star folding table leg

**2021104539**

- Height: 720 mm
- Width: 60 mm
- Rectangular tube profile
- Aluminium



ROTO rotating table support

**2022110820**

- Allows table to rotate on its leg
- Locking knob keeps table in a fixed position
- Compatible with all Lippert table legs (excluding Comet, Astro and Moon)
- Steel construction for maximum strength



MOD table leg system

**BAL-BK-1C-1622: Black**  
**BAL-CL-1C-1622 : Silver**

- This system can redefine spaces, acting as a dining table, desk, or workspace while seamlessly changing positions.



ReVace adjustable table leg Silver

**CC-RV-TL-AJ-S : Silver**  
**CC-RV-TL-AJ-BK : Black**

- Compact and super durable
- The main body is a powder coated aluminium



ReVace 900mm table rail

**CC-RV-TR-BK : Black**  
**CC-RV-TR-S : Silver**



Mito table rail single pack

**15560**

- Length 950mm
- Allows you to attach the tabletop to the wall
- Suitable for any type of camper table
- Size 1050 mm



LOC8 T5/T6 integrated table system

**LOC8**

- 1x loc8 door trim panel
- 1x loc8 folding camping table
- 1x fitting instructions

# Furniture & Fixings



Table bracket c/w sliding rail (single packing)

**STL 15348**

- With 950mm bar
- Provides strong support for the table



DLS 950mm sliding table rail with fixing kit

**6812440**

- With 950mm bar
- Provides strong support for the table
- Order in multiples of 20



DLS table storage kit

**6838050 : Black**

**6838440 : Grey**

- 2 x table storage brackets
- 2 x turn button
- 2 x turn button spacer
- 2 x turn button plate

## Vehicle **CURTAINS**



### Ford Curtains

- Specifically designed for Ford models
- Dimming feature / 180 Denier
- Includes all rails and fittings

**1715592-SS : Ford Transit Custom** 5 Window set

- SWB Barn Door, 2012 - 2024
- Black

**1715593-SS : Ford Transit Custom** 5 Window set

- SWB Tailgate, 2012 - 2024
- Black

**1715594-SS : Ford Transit Custom** 5 Window set

- LWB Barn Door, 2012-2024
- Black

**1715595-SS : Ford Transit Custom** 5 Window set

- LWB Tailgate, 2012 - 2024
- Grey / Black

**177-5593-SS: Ford Tourneo Custom** 5 Window set

- SWB Tailgate, 2024 on
- Black

**178-5593-GG: Ford Transit Custom** 5 Window set

- SWB Tailgate, 2024 on
- Grey / Black

**178-5593-SS: Ford Transit Custom** 5 Window set

- SWB Tailgate, 2024 on
- Black

# Furniture & Fixings

## Vehicle CURTAINS



### VW Curtains

- Specifically designed for VW models
- 3 and 5 window sets available
- Includes all rails and fittings

<b>VW13001 : T5 / T6 / T6.1</b>	3 Window set	<b>55527-SS : T5 / T6 / T6.1</b>	Cab Curtain set
• T5/T6/T6.1 Tailgate	• Grey / Black	• T5/T6/T6.1	• Black / Black
<b>VW13002 : T5 / T6 / T6.1</b>	3 Window set	<b>1555592-SS : T5 / T6 / T6.1</b>	5 Window set
• T5/T6/T6.1 Barn Door	• Grey / Black	• SWB T5/T6/T6.1 Barn Door	• Black / Black
<b>VW15001 : T5 / T6 / T6.1</b>	5 Window set	<b>1555593-SS : T5 / T6 / T6.1</b>	5 Window set
• LWB T5/T6/T6.1 Tailgate	• Grey / Black	• SWB T5/T6/T6.1 Tailgate	• Black / Black
<b>VW15002 : T5 / T6 / T6.1</b>	5 Window set	<b>1555594-SS : T5 / T6 / T6.1</b>	5 Window set
• LWB T5/T6/T6.1 Barn Door	• Grey / Black	• LWB T5/T6/T6.1 Barn Door	• Black / Black
<b>VW15003 : T5 / T6 / T6.1</b>	5 Window set	<b>1555595-SS : T5 / T6 / T6.1</b>	5 Window set
• SWB T5/T6/T6.1 Tailgate	• Grey / Black	• LWB T5/T6/T6.1 Tailgate	• Black / Black
<b>VW15004 : T5 / T6 / T6.1</b>	5 Window set	<b>178-5593-GG: T7</b>	5 Window set
• SWB T5/T6/T6.1 Barn Door	• Grey / Black	• SWB Tailgate, 2025 on	• Grey / Black
		<b>178-5593-SS: T7</b>	5 Window set
		• SWB Tailgate, 2025 on	• Black

### Renault Curtains

- Specifically designed for Renault models
- 3 and 5 window sets available
- Includes all required fittings

<b>1624476 : Renault Traffic</b>	4 Window set	<b>1624479 : Renault Traffic</b>	4 Window set
• SWB Barn Door, 2014 on	• Blackout	• LWB Tailgate, 2014 on	• Blackout
<b>1624477 : Renault Traffic</b>	4 Window set	<b>1624480 : Renault Traffic</b>	4 Window set
• SWB Tailgate, 2014 on	• Blackout	• SWB Barn Door, 2014 on	• Blackout
<b>1624478 : Renault Traffic</b>	4 Window set	<b>1624482 : Renault Traffic</b>	4 Window set
• LWB Tailgate, 2014 on	• Blackout	• LWB Tailgate, 2014 on	• Blackout

# Furniture & Fixings



## Horrex Ducato door fly screen H2

**130.027**

1185 x 1731 mm

- Fiat ducato right hand drive side door fly screen for a floor thickness of 26mm
- Tap guider length: 1185 mm
- Bottom guider length: 1295 mm
- Overall height: 1731 mm

## Horrex T5/T6 right hand drive door fly screen

**131.002**

- Exclusively designed for the VW transporter T5/T6
- Suitable for L/H steer and R/H steer version
- The van fly screen door VW T5/T6 has its own entry step
- Special tailoring to fit the bottom guider of the fly screen door

## Horrex MAN/Crafter right hand drive sliding door fly screen

**134.999**

- Van fly screen door VW Crafter/MAN from 2017 RHD

## Horrex Ducato L1H1 right hand drive door fly screen

**130.997**

- Tap guider length: 1185 mm
- Bottom guider length: 1295 mm
- Overall height: 1446 mm



## Hartal Fiat Ducato sliding door flyscreen

**30.01510.8401**

- Suitable for use with the Fiat Ducato sliding door



## Dometic Fiat Ducato FlyTec FT200 R/H drive fly screen

**9104117296**

- Single-pleated, high-quality fly screens suitable for sliding doors in the Fiat Ducato type 250 and vehicles with an identical design



## Dometic safety net 1060 X 350

**9104102661**

- Attaches to the slatted base with four screws while two straps connect to the ceiling

# Windows & Rooflights



BY LIPPERT

## Polyvision windows

### Principal product features & competitive benefits :

#### FRAME

- One-piece aluminium, with integrated hinge profile and thermal insulation

#### SEALING RUBBER

- Supple, frost proof compound that seals directly onto the acrylic (no hinge step to cope with).

#### ACRYLIC

- Cast 3mm acrylic, not thinner and extruded.

#### LIGHTWEIGHT CONSTRUCTION

- Typically only 0.3kg heavier than a 4.26 window and approx 2kg lighter than a plastic framed version (based on a 900x550 unit).

#### INCREASED VISIBILITY

- Lack of blind infringement into aperture giving increased clear field of vision (enabling smaller aperture sizes to be used, less weight and cost).

- Fixed by adding material (glue), not by routing and removing material.

#### EASE OF FITTING

- Off line preparation needed.
- Removal of the 'human element' of rubber windows.
- Quicker to fit; fully assembled.

#### ALSO TO CONSIDER

- Timberless aperture possibilities.
- Automated sealant application.
- Decreased inventory of parts ie, fully assembled.
- Direct interchange with aperture for non framed windows; standardisation of side manufacture.

### Roxlite® Acrylic features

- Shockproof
- Lightweight
- Thermo formable
- Excellent transparency
- Stronger than glass (due to molecule structure)
- Chemical resistant
- UV transmitting
- Easy to work with (cut and drill)



### Polyvision best selling sizes

All windows come complete with stays and catches

Product No	Width (mm)	Height (mm)	Fixing Brackets
06.25.527	500	400	8
06.25.532	500	550	10
06.25.523	600	250	6
06.25.509	600	550	10
06.25.502	700	350	10
06.25.505	700	450	10
06.25.510	750	550	12
06.25.526	800	400	10
06.25.506	900	450	10
06.25.501	900	550	12
06.25.554	1,000	500	12
06.25.518	1,000	550	12
06.25.511	1,100	550	14
06.25.512	1,300	550	14

### Polyvision Aero windows

Polyvision aero windows with black frame and privacy glass

Product No	Width (mm)	Height (mm)	Fixing Brackets
6.25.034.97.00.06	350	550	8
6.25.027.97.00.06	500	400	8
6.25.009.97.00.06	600	550	10
6.25.002.97.00.06	700	350	10
6.25.006.97.00.06	900	450	10
6.25.001.97.00.06	900	550	12
6.25.018.97.00.06	1,000	550	12
6.25.011.97.00.06	1,100	550	14
6.25.012.97.00.06	1,300	550	14

#### Polyvision fixing screws

9.25.000.00.05.08.00

- Fixing screw kit for polyvision windows

#### Polyvision fixing bracket

9.25.522.00.00.30.00

- Fixing bracket for polyvision windows

01283 586060

sales@mql.co.uk

111

# Windows & Rooflights

## Horrex DuoPliss UCS blinds Cream

- Thanks to its innovative design, UCS is the most compact and quick to mount window blind system on the market. The modular system enables us to quickly tailor it to our customers' needs to easily fit any interior. The attractive and practical design has a solid construction that ensures noise-free and hassle-free use. This is particularly important when driving a motorhome.
- The shade fabric (blackout) consists of 4 layers ensuring no light gets through and long durability. The mesh is made of high-quality polyester that provides excellent airflow and durability after pleating.
- Both the blackout fabric and the mesh are available in a fire retardant version.
- Available in various sizes (shown below) and in cream and white
- Also available a specific version for the rear window on a Ducato van with polyplastic windows (as listed below)



### Cream UCS blind codes and sizes (mm)

256.007	350 x 500	256.006	600 x 500	256.021	700 x 520	256.033	1000 x 500
256.028	350 x 550	256.055	600 x 520	256.008	800 x 400	256.015	1000 x 550
256.041	430 x 600	256.022	600 x 550	256.034	800 x 550	256.036	1100 x 550
256.027	500 x 400	256.002	700 x 350	256.016	900 x 450	256.012	1300 x 550
256.024	500 x 550	256.062	700 x 450	256.071	900 x 500	256.082	1450 x 550
256.031	600 x 250	256.032	700 x 500	256.009	900 x 550	256.011	1450 x 600

### White UCS blind codes and sizes (mm)

256.199	500 x 400	256.202	700 x 350	256.200	900 x 500	256.201	1100 x 550
256.196	600 x 550	256.198	900 x 450	256.197	1000 x 500		

### Cream DuoPliss Ducato rear window blind code and size (mm)

257.256	580 x 560
---------	-----------



## Horrex resizable UCS blind kit Cream

258.958	872 x 501
258.957	872 x 808
258.55	1172 x 501
258.951	1472 x 808

- Semi-assembled unlimited creative solutions (UCS) black-out pleated blind with insect screen and side guiding channels for rattle free use and installation on straight windows inside recreational vehicles (rv's).
- Black-out fabric: Fabric with 15 mm pleat consisting of non woven white front and dirt repelling white pet backing with built-in insulating aluminium layer.
- Fabric thickness 0.3 mm.
- Blind cord runs behind the fabric panel through attached transparent guiders
- Insect screen mesh: black polyester yarn with 15 mm pleat and 1.3 x 1.3 mm mesh opening.
- Visible black cords through holes in the mesh
- Horrex UCS is the improved version of the classic duo plissé. This resizeable blind means that coming from the 15 sizes delivered you can cut down for truly any size window.
- Super-versatile meaning quick solutions for the consumer and a lower stock of sizes needed.



# Windows & Rooflights



The hinged windows open up to a max. of 80° and the thermal insulation rating meets house building standards. We stock a wide size range of seitz S4 windows by Dometic to meet your needs.

- Comes with telescopic arms and safety handles.
- Solid quality acrylic double glazed pane
- Integrated roller blind and fly net
- Safety catches prevent the window from being opened from outside
- Outer frame black ral 9005. Inner frame cream white ral 9001
- The blind has an off-white interior with an aluminium coating to the outside which aids with thermal insulation.



## S4 Opening windows

9104115543	350 x 500	9104115559	700 x 500	9104115574	1000 x 500
9104115544	500 x 300	9104115561	700 x 600	9104115576	1000 x 600
9104115545	500 x 350	9104115565	800 x 350	9104115577	1000 x 800
9104115546	500 x 450	9104115566	800 x 450	9104115578	1100 x 450
9104115547	500 x 500	9104115568	900 x 400	9104115579	1100 x 550
9104115549	550 x 550	9104115569	900 x 450	9104115581	1200 x 300
9104115553	600 x 600	9104115570	900 x 500	9104115583	1200 x 500
9104115555	700 x 300	9104115571	900 x 550	9104115584	1200 x 600
9104115557	700 x 400	9104115572	900 x 600	9104115588	1300 x 600
9104115558	700 x 450	9104115573	1000 x 450	9104115590	1450 x 600

## S4 Sliding windows

9104100141	500 x 450	9104100175	900 x 500
9104100151	700 x 300	9104100179	900 x 600
9104100155	700 x 450	9104100185	1000 x 600
9104100153	700 x 400	9104100181	1000 x 500
9104100167	800 x 450	9104100187	1100 x 450
9104100171	900 x 400	9104100189	1200 x 600
9104100173	900 x 450		

- The classic model with acrylic glass panes and locking system.
- The front pane (from the driver's perspective) is adjustable, the rear pane is fixed.
- External and internal frames are screwed together from the inside and provide durable and effective insulation.



# Windows & Rooflights



## Dometic grey Midi Heki 700 x 500 mm lever rooflight

**9620008629 : Forced ventilation**

Weight : 8.2 kg

**9620008632 : Without ventilation**

- Separately adjustable darkening and fly screens
- Well insulated dome with double acrylic glazing
- Improved aerodynamics reduce by 20%
- Hinge and lock integrated into frame for improved safety and reliability
- Opens to three positions: fully open, half-open and bad-weather position

## Dometic Midi Heki 700 x 500 mm lever rooflight

**9620008623 : Forced ventilation**

Weight : 8.2 kg

**9620008631 : Without ventilation**

- Separately adjustable darkening and fly screens
- Well insulated dome with double acrylic glazing
- Improved aerodynamics reduce by 20%
- Hinge and lock integrated into frame for improved safety and reliability
- Opens to three positions: fully open, half-open and bad-weather position



## Dometic Midi Heki 700 x 500 mm crank rooflight

**9620008688 : Forced ventilation**

**9620008690 : Without ventilation**

- Large roof opening (700 x 500mm)
- Easy to use crank
- Assembly kits available as accessory
- Inner frame with darkening and fly screen (can be adjusted separately)
- Double acrylic glazing
- For roof thickness of 25 to 60mm

## Dometic Micro Heki 280 X 280 mm rooflight

### Forced ventilation models

**9104117679 : With fly screen / blind**

**9104117434 : Without fly screen / blind**

### Without ventilation models

**9104117680 : With fly screen & blind**

**9104117435 : With fly screen**

- Darkening screen plus various fly screen and blind options
- Adaptor frame and fitting kit sold separately



# Windows & Rooflights



Dometic Mini Heki 400 x 400 mm lever rooflight  
25 - 42mm

**9620008619 : Forced ventilation**  
**9620008620 : Without ventilation**

Weight : 3.3 kg

- Maximum opening position 50 degrees (roof thickness 25-42mm)
- Easy adjustment with operating lever
- Inner frame with blind and fly net
- Opens in 3 positions

Dometic Mini Heki 400 x 400 mm lever rooflight  
43 - 60 mm

**9620008612 : Forced ventilation**  
**9620008618 : Without ventilation**

Weight : 3.3 kg

- Handle operated, three positions
- Highly insulating, double acrylic glazing, Aerodynamic



Dometic Mini Heki S rooflight  
(Forced ventilation optional)

**9104100289 : 25 - 42 mm**  
**9104100290 : 43 - 60 mm**

- Designed for standard roof openings (400 x 400mm) and is easy to open thanks to its handles



Dometic red  
Heki fixing kit

**9104100248**

- Assembly kit for heki 2, 3 and 4
- Red
- For roof thickness : 53 - 60 mm



Dometic yellow  
Midi Heki fixing kit

**9104100246**

- Assembly kit for Midi Heki
- Yellow
- For roof thickness : 39 - 46 mm

# Windows & Rooflights



## Dometic Heki 3 plus rooflight without lighting

**9104115635**

900 x 655 mm

- Cut out : 900 x 655mm
- Weight : 15kg
- Double pleated blind, fly screen, double acrylic glazing, crank handle

## Dometic Heki 2 deluxe rooflight

**9104100240**

900 x 655 mm

- Complete with LED lights
- Weight: 11kg
- Cutout: 900 x 655mm
- Possible roof thickness: 25-60mm
- Maximum opening angle: 55degrees



## Dometic Heki 2 rooflight

**9104100235**

900 x 655 mm

- Net weight 11 kg
- Cut out 900 x 655mm



## Dometic adapter frame

**9104116107 : Midi Heki S rear**  
**9104118059 : Micro Heki**

- Adapter frames for Dometic Midi Heki S and Micro Heki rooflights



## Dometic Micro Heki fixing kit

**9104118049 : 26 - 27 mm**  
**9104118050 : 28 - 29 mm**  
**9104118057 : 42 - 43 mm**

- The fixing kit comes with all the screws and fixtures required to install the roof vent



## Dometic Mini Heki adapter frame for trapezoidal sheet metal roofs

**9104114007**

- For Fiat Ducato type 250 and 290 with trapezoid-shaped, sheet metal roof
- Suitable for roof cut-outs 400 x 400mm
- Ideal for Mini Heki rooflights or air conditioners

# Windows & Rooflights



## Carbest rooflight with LED lighting

**318540 : Forced ventilation**  
**31854 : Without ventilation**

700 X 500 mm  
 Weight : 8 kg

- Double glazing and UV resistant rays
- Blackout blinds and integrated mosquito nets
- LED and integrated switches
- Maximum aperture at 60 degrees
- Easy operation with gas springs
- For roof thickness from 25 to 60mm
- Cutting dimensions: 702 x 502mm
- Panoramic roof 700 x 500 mm
- Hood: tinted acrylic glass

## Remitop Vario 2 Rooflight

**10030461 : 400 x 400**  
**10036788 : 900 x 600**

400 x 400 mm  
 900 x 600 mm

- For roof thickness of 24 - 35mm
- Black out blind & insect protection
- 45° opening



## Maxxfan Deluxe

**7500Ki : 350 x 350 Smoke**  
**7500KI40 : 400 x 400 Smoke**  
**7500KI40T : 400 x 400 Clear / tint**

350 X 350 mm  
 400 x 400 mm  
 400 x 400 mm

- Fits standard European 40cm x 40cm motorhome/caravan roof openings and USA 35 x 35 cm RV roof openings.
- Opens and closes automatically with a remote control or, by using a manual knob located on the ceiling unit.
- Includes a powerful 10-speed fan, thermostat, air intake and exhaust functions.
- 2 year international warranty as standard



## Maxxfan Dome Plus

**3810B : Black with LED light**  
**3810W : White with LED light**  
**3812B : Black without LED light**  
**3812W : White without LED light**

- 12v exhaust fan
- Designed for rooftop or sidewall ventilation applications
- 6" exhaust only fan with manual lift lid
- Locking lid with single hand push button operation
- Removable screens make cleaning a breeze
- For 1" roof thickness - extensions available up to 6"
- Packaged with a matching fan guard that must be used for sidewall applications



## Maxxshade for Maxxfan

**3900i : Standard model**  
**3901I : Plus model with LED light**

- Perfect for blocking out sunlight and UV rays
- Fully retractable, spring loaded roller shade with secure "snap-lock"
- Install using the existing 4 screw holes



# Windows & Rooflights



## SkyMaxx LX rooflight

**00-97100i : 23 - 42 mm**  
**00-97000i : 42 - 60 mm**

700 x 500 mm

- Manual lift with 3 open positions
- Pleated screen and blind
- Fits 700 x 500mm roof opening
- Forced and non-forced ventilation
- CE and R43 approval. ROHS compliant

## SkyMaxx LX Plus rooflight

**00-97110i : 23 - 42 mm**  
**00-97010i : 42 - 60 mm**

700 x 500 mm

- Interchangeable panels- can be both vented and non vented
- Fits roof thickness from 23 to 60 mm
- Manual lift with 3 open positions
- Pleated screen and blind
- Skymaxx LX fits 700 x 500 mm roof opening
- With 12v LED lights incorporated into the frame (12v dc 2amp)



## SkyMaxx rooflight

**00-97500i : 23 - 60 mm**

400 x 400 mm

- Manual lift with 3 open positions
- Pleated screen and blind
- Fits 400 x 400mm roof opening
- Forced and non-forced ventilation
- For 23mm to 60mm roof thickness
- CE and R43 approval. RoHS compliant



## SkyMaxx Plus rooflight with LED lighting

**00-97510i : 23 - 60 mm**

400 x 400 mm

- Features integrated LED lighting
- Manual lift with 3 open positions
- Pleated screen and blind
- Skymaxx fits 400 x 400mm roof opening
- Forced and non-forced ventilation optional
- LED lighting (12vdc, 2 amp)
- For 23mm to 60mm roof thickness, no cutting or adapters required



# Windows & Rooflights



Dometic GY20 roof vent

9107300319

- Effective roof ventilator powered without a motor
- Efficient noiseless operation that works through differential pressure
- Robust waterproof roof dome
- Noiseless motor-free roof ventilator
- Provides constant ventilation.
- Designed for roofs with a thickness of 25-45mm



FAWO Mushroom vent black

00175T01081

- Suitable for roof thickness up to 50mm



**VEGAS**  
*It's back baby*

Ask your sales representative for details and how to qualify for Vegas.

# Vehicle Accessories



Please note images show are left hand versions, but all codes displayed are right hand versions.

## Scopema RIB 2<sup>nd</sup> Generation seat swivels

### DRIVER SWIVEL BASES

- CBT013RG2C/GB : T5 with Riser*
- CBT016G2C/GB : Ducato GB*
- CBT019G2CGB: Transit Custom*
- CBT015G2/GB : M3 Sprinter/Crafter RHD*
- CBT021G2GB : New Sprinter*
- CBT023G2GB : VW Crafter from 2017 & MAN TGE*

### PASSENGER SWIVEL BASES

- CBT013RD2C/GB: T5 GB*
- CBT016D2C/GB : Ducato GB*
- CBT019D2CGB: Transit Custom*
- CBT015D2/GB : M3 Sprinter/Crafter RHD*
- CBT021D2GB : New Sprinter*
- CBT023D2GB : VW Crafter from 2017 & MAN TGE*

- Original seat fixation points , Steelplates 5 mm (Thick) , Thickness : 23 mm
- Weight : 12 Kg (depending on the model) , Stabilization by Teflon supports
- Automatic stoppage facing the road , Easy unbolt
- Middle offset rear side : 60 to 140 mm (depending on the model)

## Scopema RIB 3<sup>rd</sup> Generation seat swivels

### DRIVER SWIVEL BASES

- CBT013G3R/GB : VW T5-T6 RHD (Battery) + Handbrake LWG KIT*
- CBT013RD2C : T5 (no riser)*
- CBT016G3/GB : Ducato GB*
- CBT019G3CGB : Transit Custom*
- CBT020G3GB : Renault Traffic X82*
- CBT021G3GB: New Sprinter*
- CBT024G3GB: Ford Custom V710*

### PASSENGER SWIVEL BASES

- CBT013D3/GB : VW T5-T6 RHD*
- CBT016D3/GB : Ducato GB Swivel Base*
- CBT019D3CGB : Transit Custom*
- CBT020D3GB : Renault Traffic X82*
- CBT021D3GB: New Sprinter*
- CBT024D3GB: Ford Custom V710*

- Enlarged central hole , Easy unlocking , Thinner: only 21 mm , Stabilizer pins
- Lighter with a weight of 8.5 kilos (depending on the model)
- Using the original mounting points , Automatic forward-facing locking



Handbrake adapters

**ACAFMC : VW Crafter**  
**ACAFMS : New Mercedes Sprinter**

- Handbrake adapter for use with Scopema RIB swivel bases
- For use with VW Crafter or Mercedes Sprinter vehicles



Handbrake lowering kit

**ACAFMTC : Ford Transit Custom**

- Handbrake lowering kit for use with Scopema RIB swivel bases
- For use with Ford Transit Custom vehicles



Handbrake cover

**AHPFT5 : VW T5**

- Handbrake cover for use with Scopema RIB swivel bases
- For use with VW T5 vehicles



# Vehicle Accessories



## CTA swivel base plates

### Ford Version

- Transit - from 2014
- Tourneo custom
- Transit custom - from 2012
- Weight: 8.7kg
- Powder coated
- Colour: Black
- Size: 474 x 455 x 51 mm

### VW Version

- Transporter T5, T5.1, T6, T6.1 - from 2003
- Weight: 7.3kg
- Powder coated
- Colour: Black
- Size: 434 x 429 x 38 mm

**CTACUSTOMPLATE** : Ford Transit, Custom & Tourneo  
**CTAT6PLATE**: VW T5, T5.1, T6, T6.1



## CTA driver seat handbrake adaptors

### Ford Version

- Transit custom

### VW Version

- Transporter T5, T5.1, T6, T6.1

**CTACUSTOMADAPTOR** : Ford transit custom  
**CTAT6ADAPTOR**: VW T5, T5.1, T6, T6.1



## CTA Smart kits

- Each kit includes a forward, backward or face to face upper frame with pre-mounted seat belts, floor anchoring brackets, chassis fixing screws kit and assembly instructions. All the components of Smart kits are approved according to current regulations.

**CTACRAFTER** : VW Crafter Off-axis belt frame  
**CTADUCATO** : Fiat Ducato Off-axis belt frame



## CTA Smart kits - Combi ready

- Each kit includes a forward, backward or face to face upper frame with pre-mounted seat belts, floor anchoring brackets, chassis fixing screws kit and assembly instructions. All the components of Smart kits are approved according to current regulations.

**CTADUCATOCOMBI** : Fiat Ducato Off-axis belt frame



## CTA Isofix for off axis double seatbelt frame

### CTAISOFIX

- CTA ISOFIX For off-axis double seat belt frame
- Series 01030 - UK



## CTA Wall mount headrest

### CTAHEADREST

- CTA Wall Mount Headrest
- Includes padding.
- No trim

# Vehicle Accessories



## RIB Beds

### Other beds are available on request

Below are the most popular sizes and model of RIB bed, but we can supply many other types and types, please don't hesitate to get in touch if you have any particular requirements.

**RIB112BRICKISO : RIB Altair Bed 112cm Brick with Isofix fixed frame type C**

**RIB112PLAINISO : RIB Altair Bed 112cm no trim fixed frame type C and Isofix**

**RIB112SIMORAISO : RIB Altair Bed 112cm Simora with Isofix fixed frame type C**

**RIB112BARLOISODL : RIB Altair Bed 112cm Ford Barlo with Isofix. 105 degree handle / 140x200 cut out**

**RIB112PLAINISODL : RIB Altair Bed 112cm no trim with Isofix. 105 degree handle / 140x200 cut out**

**RIB112PLUSISODL : RIB Altair Bed 112cm Ford Plus with Isofix. 105 degree handle / 140x200 cut out**

**RIB112BRICKSLIDER : RIB Altair Bed 112cm Brick with Slider and Isofix frame type A**

**RIB112PLAINSLIDER : RIB Altair Bed 112cm no trim with slider and Isofix**

- Manufactured by SCOPEMA, RIB beds offer the highest possible safety standard combined with fantastic quality, durability and comfort.
- Double back rest – for complete sleeping comfort. The bench seat easily transforms in sleeping with unlocking handle.
- The curved sitting and backrest turns inside to obtain a flat sleeping.
- Bench seats can be placed in most vehicle models

Code	Model	Upholstery design	Width (cm)	Seats	IsoFix	Slider	Other Details
RIB112BRICKISO	Altair	VW Brick	112	2	Y	N	-
RIB112PLAINISO		No trim	112	2	Y	N	-
RIB112SIMORAISO		VW Simora	112	2	Y	N	-
RIB112BARLOISODL		Ford Barlo	112	2	Y	N	105 Degree handle
RIB112PLAINISODL		No trim	112	2	Y	N	105 Degree handle
RIB112PLUSISODL		Ford Plus	112	2	Y	N	105 Degree handle
RIB112BRICKSLIDER		VW Brick	112	2	Y	Y	-
RIB112PLAINSLIDER		No trim	112	2	Y	Y	-



## RIB Altair Seat Anchorage

### RIB-FK

- Easy to install with easy to follow fitting instruction.
- Super strong design and materials.
- Complete with all bolts, washers and fixings.
- Will fit both slider and non slider rib base frames.
- Will fit 112, 120 130 and 150cm rib frames.
- Tested with over 10,000kgs of applied force.
- Allows for variable positioning depending on side furniture and required seat position.
- Galvanized finish for extra protection.

# Vehicle Accessories



Ideatermica internal 3 piece thermal screens

**TR1010 : VW Crafter**  
**TR106 : Fiat Ducato**

**TR310 : Ford Custom**  
**TR905 : VW T6**

- Internal thermal blinds for various vehicles made by Ideatermica



Ideatermica external thermal screens

**AB1010: VW Crafter External Thermal Blind**  
**AB106 : Fiat Ducato External Thermal Blind**  
**AB310 : Ford Custom External Thermal Blind**  
**AB905 : VW T6 External Thermal Blind**

- External thermal blinds for various vehicles made by Ideatermica



Reimo 3 piece internal thermal screens

**37273 : Renault Traffic Isoflex Thermal Screens 02-14**  
**37281 : VW T5 Isoflex Thermal Screens from 2003**  
**37313 : Ducato X290 Isoflex Thermal Screens From 2015**

- Internal thermal blinds for various vehicles made by Reimo
- 3 Pieces : 2 side windows and front window.

# Vehicle Accessories









## Voos 3 piece internal thermal screen sets

Code	Vehicle	Pieces	Type
THRML3104	VW T4 1999 - 2003	3	Internal
THRML3105	VW T5/T6 2003 - on	3	Internal
THRML3107	VW Caddy/Caddy Maxi	3	Internal
THRML3108	VW Crafter 2006 - 2017	3	Internal
THRML3109	VW Crafter 2017 - on	3	Internal
THRML3202	Renault Trafic/Vivaro 2014-on	3	Internal
THRML3203	Nissan Master/Movano 2010-on	3	Internal
THRML3301	Ford Custom Van/Kombi 2013-on	3	Internal
THRML3303	Ford Transit (2001 - 2013)	3	Internal
THRML3304	Ford Transit 2013-onwards	3	Internal
THRML3403	Mercedes Sprinter 2006 - onwards	3	Internal
THRML3601	Fiat Ducato/ Peugeot Boxer 1994 - 2006	3	Internal
THRML3602	Fiat Ducato/ Peugeot Boxer 2006 - on	3	Internal

- Internal thermal blinds for various vehicles made by Reimo
- 3 Pieces : 2 side windows and front window.

# Vehicle Accessories

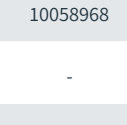
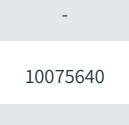
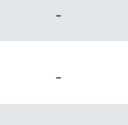
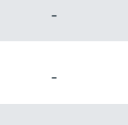
## REMIfront cab blinds for the FIAT Ducato

Built	Product	Front (left- and right-hand drive)					Side windows	
		Without sensors	Sensor package	Sensor package	Sensor package, small	Sensor package, large*	Left	Right
2006 - 2011 Model X250	REMIfront IV	10032228					10032233	10032234
09/2011-2014 Model X250		10043741					10043742	10043743
From 2014 Model X290		10056725	10058968	-	-	-	10043742	10043743
From 2019 Model X290		10056725	-	10075640	-	-	10043742	10043743
From 2021 Model X290**		10076224	-	-	10078756	10078757	10078765	10078764
All vehicle models from 2006	Adapter for sun visor	10057562					Optimises and extends the function of the sun visor. After the installation of REMIS blinds, the adapter enables the visor to be used at the side.	
	Lower sun screen	10036732					Further reduces the amount of light entering the cab at the bottom of the front blinds.	

\* With or without mirror

## REMIfront cab blinds for the Peugeot Boxer & Citroën Jumper

Basic vehicle: Fiat Ducato

Built	Product	Front (left- and right-hand drive)					Side windows	
		Without sensors	Sensor package	Sensor package	Sensor package, small	Sensor package, large*	Left	Right
2006 - 2011 Model X250	REMIfront IV	10032228					10032233	10032234
09/2011-2014 Model X250		10043741					10043742	10043743
From 2014 Model X290		10056725	10058968	-	-	-	10043742	10043743
From 2019 Model X290		10056725	-	10075640	-	-	10043742	10043743
From 2021 Model X290**		10076224	-	-	10078756	10078757	10078765	10078764
All vehicle models from 2006	Adapter for sun visor	10057562					Optimises and extends the function of the sun visor. After the installation of REMIS blinds, the adapter enables the visor to be used at the side.	
	Lower sun screen	10036732					Further reduces the amount of light entering the cab at the bottom of the front blinds.	

\* with or without mirror

\*\* The changeover to model year 2021 may take place later for Peugeot Boxer & Citroën Jumper models. Please check your vehicle.

# Vehicle Accessories

## REMIfront cab blinds for the Ford Transit (Model V363)

Built	Front, left-hand drive		Front, right-hand drive		Side windows	
	Light and rain sensor on the interior mirror Visibility (Picture 1)	Without visibility package	Light and rain sensor on the interior mirror Visibility (Picture 1)	Without visibility package	left	right
2014 - 2019	-	10058218	-	10066661	10058219	10058220
from 2019	10079895*	10075051	10079895*	10075051	10075658	10075659

\* from 2019, the systems are suitable for both left- and right-hand drive



## REMIfront cab blinds for the Ford Transit Custom (Model V362)

Built	Front (left-hand drive)			Side windows	
	Without visibility package	Visibility package 2	Visibility package 3	Left	Right
2012-2017	10058294 (image 1)	10068262 (image 2)	10068263 (image 3)	10058295	10058296
From 2018	10078465 (image 1)	10078466 (image 4)	10078466 (image 4)	10078467	10078468

\* from 2018, the systems are suitable for both left- and right-hand drive



# Vehicle Accessories

## REMfront cab blinds for the Mercedes Benz Sprinter

Built	Front (left-hand drive)				Front (left- and right-hand drive)		Side windows (without entry handle)		Side windows (with entry handle)	
	Straight mirror base plate (image 1)	Angled mirror base plate (image 2)	Rain sensor (image 3)	Lane k./FB package LA1/JP4/JP2 (image 4)	Sensor package, small* (image 5)	Sensor package, large** (image 6)	Left	Right	Left (image 7)	Right (image 7)
2006 - 2018	10021022	10023924	10059902	10058221	-	-	10021023	10021024	-	-
from 2019	-	-	-	-	10077542	10077541	10077544	10077546	10077543	10077545



## REMfront cab blinds for the VW Crafter

Built	Base vehicle	Front (left-hand drive)				Front (left- and right-hand drive) With upper storage compartment	Side windows (without entry handle)	
		Straight mirror base plate (image 1)	Angled mirror base plate (image 2)	Rain sensor (image 3)	Lane k./FB package LA1/JP4/JP2 (image 4)		left	right
2006 - 2016	Mercedes Sprinter	10021022	10023924	10059902	10058221	-	10021023	10021024
from 2017	MAN TGE	-	-	-	-	10075916	10075919	10075918

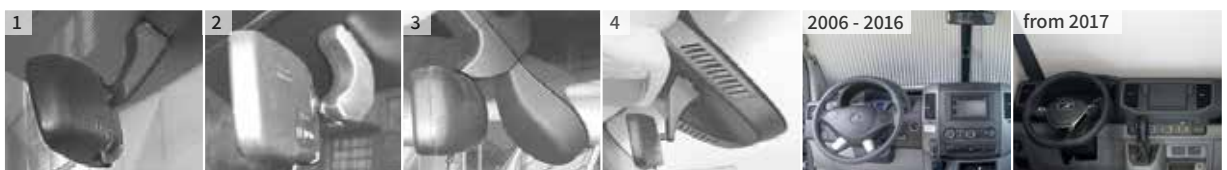

# Vehicle Accessories

## REMIfront cab blind for the MAN TGE

Built	Front (left- and right-hand drive) With upper storage compartment	Side windows	
		Left	Right
From 2019	10075916	10075919	10075918



## REMIfront cab blinds for the Vauxhall Movano

Built	Base vehicle	Front (left- and right-hand drive) With upper storage compartment				Front (left-hand drive)			Side windows	
		without sensors (img 1 & 2)	with rain sensor (image 3)	Sensor package, small (image 4)	Sensor package, large* (image 5)	without sensors (image 2)	with rain sensor (image 3)	with driver assistance systems (image 6)	left	right
04/2011 - 08/2019	Renault Master	10043735	10049610	-	-	-	-	-	10043739	10043740
09/2019 - 07/2021	Renault Master	-	-	-	-	10081805	10081807	10081809	10043739	10043740
from 07/2021	Fiat Ducato	10076224	-	10078756	10078757	-	-	-	10078765	10078764

\* with or without mirror





# Vehicle Accessories

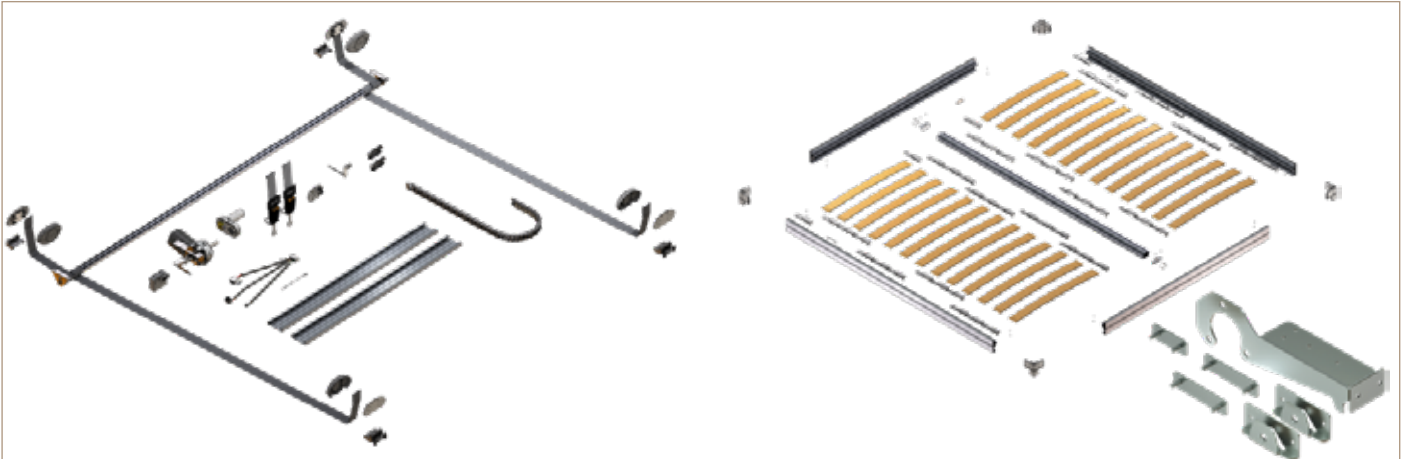

## Lippert smart bed system

**2021104193 : Electronic bed lifting system (A)**

**12678-A000-00-000 : Smart bed frame (B)**

**678-800-0-ZF00 : Smart bed fixing brackets (C)**

- Lippert smart bed system is engineered to lift and / or lower in the rear garage, above the dinette, or driver's seat. High-performing gear motor with optional integrated encoder. The device fits completely under the bed frame and offers maximum fitting flexibility. Complete bed lifting system is ready for installation (comes with or without the bed frame). Includes manual emergency system. Heavy-duty steel and aluminium construction
- The system is made up of three parts : The electric bed lifting system(A), the smart bed frame (B) and the fixing brackets (C)

### Electronic bed lifting system (A)

- Includes all components required: motor unit, stabilization rails, shafts, fixing plates, and 4 m belts
- Adapts to standard measurements up to a maximum of 2.000 × 1.600 mm
- Includes a Lifty handle for manual use

### Smart bed frame (B)

- Allows you to create a custom bed frame for your unique vehicle space
- Includes standard wooden slats and slat holders that can be cut to size

### Fixing Brackets (C)

- Attaches the smart bed frame (B) to the bed lifting system (A)
- Provides a customized bed solution for each unique vehicle layout



## Nuova Mapa bunk ladders

0602153/135 : 1350mm  
0602153/150 : 1500mm  
0602153/170 : 1700mm



## Lippert Titta extendable bunk ladder

**2021104262 : 1250 - 2100 mm**

- Extendable aluminium bunk ladder



## Lippert slide out bunk ladder

**2021104316 : 1000 mm**

- Slideout aluminium bunk ladder that fold securely under bed, Strong and lightweight
- Bolts onto underside of the bed
- Bottom feet maximize friction to avoid slipping and ensure stability

# Vehicle Accessories



Lippert Innolight gradino slide-out electric step kit

**2021104109 : 440 mm width**  
**2021104075 : 550 mm width**

- High power 12v motor , Energy input: 2.5a
- Waterproof sensor for open step warning light
- Patented quick release system for use in emergencies
- High motion speed, from open to closed in 2.5 seconds
- Anti-slip and aluminium foot board

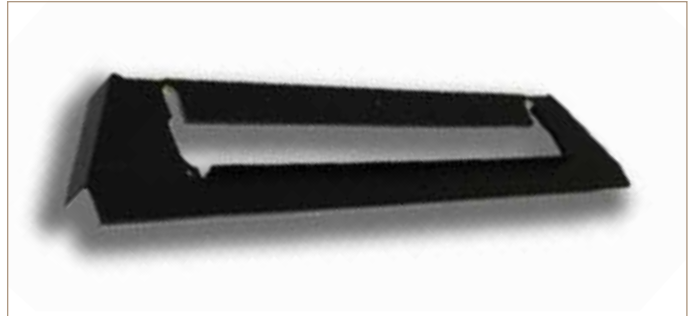

Lippert Innolight step front cover

**2020344560 : Cover for 440 mm width step**  
**2020344562 : Cover for 550 mm width step**

- Front covers for the innolight steps
- Integrates the step with the vehicle for a clean, seamless look



Lippert Innolight fixing kits

**2021104102 : VW Crafter**  
**2021104052 : Mercedes Sprinter**  
**2022005213 : Fit Ducato , Citroen Jumper, Peugeot Boxer**

- Fixing kit for the Lippert Innolight electric step

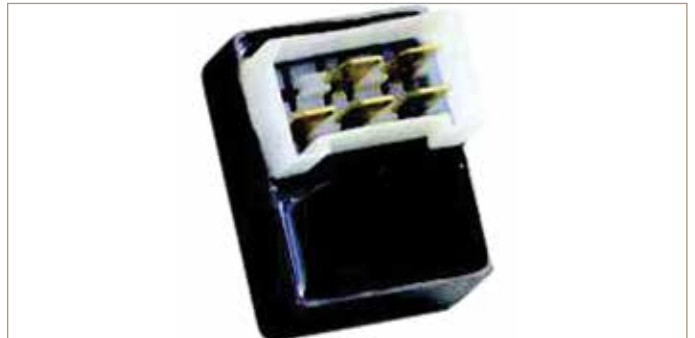

Lippert Innolight automatic storing device

**2021104044**

- Enables automatic storing of electric steps when starting the vehicle's engine
- Prevents steps from opening while driving
- Compatible with Alanera and Innolight steps



Kopak VW rear threshold cover (tailgate)

**G1337**

- VW T5 / T5.1 / T6 / T6.1
- Rear ABS threshold cover tailgate with plugs
- Straight replacement
- Easy to fit



Kopak VW rear threshold cover (barn door)

**G1338**

- VW T5 / T5.1 / T6 / T6.1
- Rear ABS threshold cover barn door with plugs.
- Straight replacement
- Easy to fit



Kopak VW extra deep side load door step

**G1339**

- VW T5 / T5.1 / T6 / T6.1
- ABS extra deep side load door step
- Straight replacement
- Easy to fit

# Vehicle Accessories



VW Crafter/ MAN TGE rear door ladder

**RL2017**

- Rear door ladder for VW crafter or MAN TGE
- 38mm Steel
- Premium quality, highly durable power coated (black)
- Fits directly onto the vehicles existing hinges



VW Crafter/ MAN TGE steel spare wheel carrier

**SWC2017**

- Spare wheel carrier for VW crafter or MAN TGE
- 38mm Steel with premium quality, highly durable power coated (black)
- Wheel rack will fit any wheel and tyre combination
- Fits directly onto the vehicles existing hinges

# Vehicle Accessories



Reimo multirails

**90156 : Offside VW T4/T5 SWB : Black**  
**901561 : Nearside T4/T5 SWB : Black**  
**90157 : Offside & nearside T4/T5/T6 LWB : Black**  
**90193 : Offside VW T7 / Ford V710 SWB : Black**  
**901931 : Nearside VW T7 / Ford V710 SWB : Black**

- Reimo multirail for various vehicles.
- Allows the easy fitting of a drive away awning, canopy and much, much more.



Reimo Multirail end caps

**90154 : Multirail Nearside End Cap**  
**90155 : Multirail Offside End Cap**

- End caps for use with the Reimo multi-rail
- Finishes the multi-rail off nice and cleanly, plus improves water run off



ReVace Awning rails



**AR-RV-MR-T5-LED-BK : Near side : VW T5, T5.1, T6, T6.1 SWB, with LED, Black**  
**AR-RV-MR-TC-LED-BK : Near side : Ford Transit Custom, with LED, Black**

**AR-RV-MR-T5-SK-BK : Near side : VW T5, T5.1, T6, T6.1 SWB, no LED, Black**  
**AR-RV-MR-T5-SK-BK-D : Drivers side : VW T5, T5.1, T6, T6.1 SWB, no LED, Black**  
**AR-RV-MR-TC-SK-BK : Near side : Ford Transit Custom, no LED, Black**

- Tapered end caps for a stylish, moulded fit.
- Rail accepts threaded hangers – supplied. (perfect for hanging wetsuits or threading a washing line)
- Accommodates both 6mm and 4mm kador strip or awning flange
- Water channel to redirect water on to front windscreen (perfect for elevating roof run off water)

#### LED kit includes

- 2650 mm Aluminium awning rail, 2 x flexible end caps, 2 x threaded hangers, Fixing adhesive, 2200 mm LED waterproof strip pre fitted to awning, 3m cable, Inline fuse and fuse holder, LED light switch, electrical crimps, heat shrink and conduit.

#### Non LED kits includes

- 2650mm Aluminium awning rail, 2 x flexible end caps, 2 x threaded hangers, Fixing adhesive Tapered end caps for a stylish, moulded fit.

# Vehicle Accessories

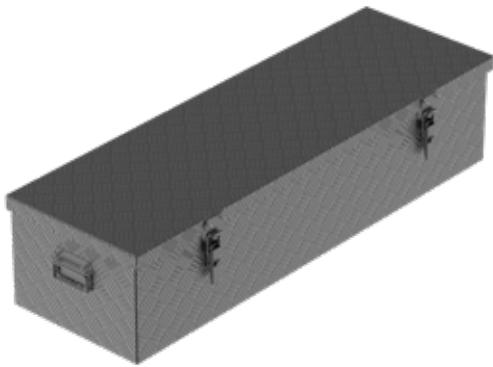

Lockable Luggage box in Black

**64500**

- Size: 1050 x 325 x 240 mm
- Luggage storage box, lockable for added security



Light bar with repetition for number plate in black

**65002**

- The lighting strip with license plate repeater in elegant black from EuroCarry is the ideal addition to your caravan.
- As an established manufacturer of high-quality caravan accessories, EuroCarry offers a sophisticated solution with this lighting strip that combines both functionality and style.

Eurocarry bike rack for Mercedes Sprinter VW Crafter MAN TGE

**66201 : 2 Bike**  
**66401 : 4 Bike**

- Premium bike carry racks in black
- Mercedes-Benz Sprinter from 07/2006,
- VW Crafter from 07/2006 to 2016
- VW Crafter from 2016, MAN TGE
- Completely pre-assembled
- Installation without gluing
- Attachment to existing door hinges
- Swivels to the left to open the door, even when loaded (note: max. door opening 90°)
- Fixed rail bracket can be used as a high loader or with lighting strip as a low loader



Eurocarry bike rack for Fiat Ducato, Citroen Jumper, Peugeot Boxer

**66201 : 2 Bike**  
**66401 : 4 Bike**

- Premium bike carry racks in black
- Completely pre-assembled
- Installation without gluing
- Attachment to existing door hinges
- Swivels to the left to open the door, even when loaded (note: max. door opening 90°)
- Fixed rail bracket can be used as a high loader or with lighting strip as a low loader

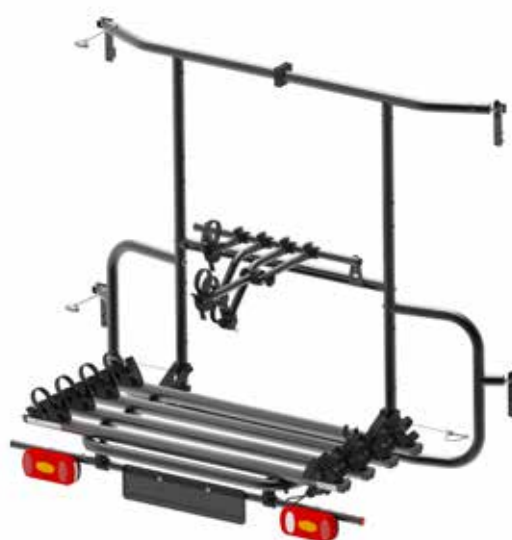

# Vehicle Accessories



Summit Steering Wheel Lock with T Bar Design

**SUM-902**

- Padded anti-slip handle
- Fits across the top section of the steering wheel
- Spring-loaded clamp
- Soft rubber layer to prevent scratches to the steering wheel
- Multi-way adjust the clamp to the size of the steering wheel
- Complete with 2 keys and easy instructions



SAS Universal Crook Steering Wheel Lock

**5880765**

- Sturdy quad claw, twin bar design
- Simple and quick fit to the steering wheel
- Ratchet design allowing quick fitting without using key
- Easy to operate integral release lock, supplied with 2 keys
- PVC-coated claws prevent damage to the steering wheel
- Slide together for easy storage
- Blocks access to steering airbag

## MQL.CO.UK

*More than you think*

The MQL website grows and grows each year, not only are we putting more and more on the website, you can already :

**ORDER ONLINE** : You can order more and more products easily and at any time online.

**ONLINE CHAT** : Speak to our dedicated CS team about any of our products.

**LOYALTY POINTS** : You can earn points by ordering online and then use these points to pay for your goods.

**MOBILE APP** : We have a dedicated mobile app for you to use.

Plus a whole lot more like downloading documents, getting a statement, paying for invoices.

# TV & Satellite



-   
**2.4"**  
 2.4" Touch Screen
-   
**4G**  
 4G High Speed Internet
-   
**140**  
 140+ countries
-   
**SIM-Free**  
 SIM-Free
-   
**FREE**  
 Roaming Fee
-   
**10hr**  
 10H Battery Life
-   
**Ultra Slim Design**  
 126mm x 66mm x 12.6mm

## Glocalme mini turbo U30 portable Wi-Fi

### GlocalmeMini

Screen: 2.4 inch

126 X 68 X 12 mm

- Sim free
- Excellent performance
- Wi-Fi: 2.4G; 802.11 b/g/n
- No contract, no roaming fees
- 10 hours of use
- Battery: 3000mAh / 3.8V; Power Input: 5V 2A
- User friendly app
- Shareable, private & safe
- USB Port: Type-C (input); SIM Slot: 1 Nano SIM



## Glomex Oasis TV aerial wall mount automatic amplifier

### T480AGC

Width: 250 mm

- Base diameter; 25 mm (1")
- Amplifier by-pass; No
- Antenna weight; 350g
- Power consumption; 20 ma
- Angle of reception; 360°
- Power supply; 12/24V DC
- Frequency range; 40/890 mhz
- Amplifier adjustable gain; Yes



## Glomex Escape TV aerial

### C3779AGC

Width: 370 mm

- Kit includes: wall mount automatic amplifier, roof mount, 1.5m tv cable cord and 5m coax cable.



## Maxview Gazelle aerial

### B2414 : White

### B2414G : Grey

Height: 14cm

Weight: 0.9 kg

- No manual alignment needed
- Compatibility: SD, HD, 3D, 4K TV; FM & DAB radio
- Power: 12/24V DC or 230V AC (variant-dependent)
- Minimal roof space needed
- Frequency range: UHF TV & VHF radio (40 - 860 MHz)
- Mounting options: Adhesive sealant, screws (included)
- Supports all digital terrestrial TV & radio
- Gain: Up to 18dB with included variable booster
- Housing: UV-stable ABS

# TV & Satellite



Fawo TV bracket 2 arms

**01608T78599**

350 x 350 mm

- Fawo TV bracket 2 arms
- With comfortable wall security locking
- Quick release for easy screen removal



Fawo Medio HTFT bracket

**01608T96033**

- TV bracket which articulates in four directions :
  - left and right
  - up and down.
- TV can be easily lifted off for out-of-sight storage.
- Weight of unit: 0.8 kg.



Fawo Sky Basic 2 TV bracket

**01608T02199SB**

122 x 210 mm

- Single hinge arm
- 1 articulating point
- Max load : 7kg



Sky2 TFT screen bracket double hinged arm Silver

**01608T71099**

- Double hinged arm
- 2 articulating point's
- Max load : 8kg



Sky3 TFT screen bracket Silver

**01608T72099**

- Triple hinged arm
- 3 articulating points
- Max Load : 8kg



# Household



CBE Grey LPG and soporific gas detector

**232800**

- Detects LPG gas and soporific gas
- The sensitivity can be adjusted
- Easy to install- only 12v supply needed
- Sensor consumption: 75ma



CBE Grey carbon monoxide gas detector

**232802**

- Easy to install- only 12v supply needed
- Comes retail blister packed
- Protects against carbon monoxide



Kidde carbon monoxide alarm

**K7CO**

- Battery operated (included)
- Easy to install unit
- Comes retail blister packed
- Protects against carbon monoxide



Kidde smoke alarm

**DY29B**

- Battery operated (Included)
- Test button
- Low battery warning
- Hush feature



Kidde carbon monoxide + smoke alarm combi

**K10SCO**

- Battery powered alarm
- Easy to install: mount, tamper resistant bracket to wall (screws included), attach alarm and turn to adjust

600g ABC Powder red aerosol fire extinguisher



**7811**

600g

- Easy to use aerosol fire extinguisher, Kite marked to BS 6165
- For use with A, B and C type and electrical
- Class A : Wood, paper, textile and similar
- Class B : Flammable liquids, Class C : Flammable gases
- Not for use with deep fat fires

950g BC Powder red aerosol fire extinguisher

**7812**

950g

- Easy to use , aerosol fire extinguisher, Kite marked to BS 6165
- For use with B, C type and electrical
- Class B : Flammable liquids
- Class C : Flammable gases
- Not for use with wood, paper, textile and similar or deep fat fires



# Awnings & Tents



## Skypod Lair

### SKP001 : Skypod Lair roof top tent

- This is a premium, hard top roof top tent made from the very best materials, featuring various patented technology and design to elevate it above its rivals.
- Patent gas strut mechanism, easy and quick to set up and fold down
- New patented Z shaped style to allow for quicker, easier pitching, additional strength and an extremely low profile when closed.
- Black hard shell on top with texture, high quality, no concern while in bush, less wind noise during driving
- Track frame on sides to have more flexibility to mount solar lights or awning and Tarps etc.
- Includes two aluminium roof bars can bear 100kgs cargo on top of the hard shell so you still have additional loading capacity if required.
- Spacious inner space for 2-3 persons
- Big screened windows on three sides and double layer front door for easy entrance
- With integrated LED strip, detachable (battery pack not included)
- 7cm high-density mattress provides comfortable sleeping experience
- Two big shoes pockets, detachable and for more storage
- Telescopic aluminium alloy ladder included with a high maximum load of 150kg

<b>Inner size (cm)</b>	200 x 140 x 100
<b>Closed Size (cm)</b>	210 x 140 x 28
<b>Total weight (kg)</b>	75
<b>Sleeping Capacity</b>	2 - 3
<b>Weight Capacity (kg)</b>	300

<b>Internal material</b>	190G Rip-Stop Polycotton with P/U 2000mm HH
<b>External material</b>	220D Rip-Stop Poly-Oxford with Silver Coating and P/U 3,000mm
<b>Mattress</b>	Mattress: 5cm High Density Foam + 5cm EPE
<b>Shell</b>	Aluminium honeycomb plate
<b>Frame</b>	Patented aluminium gas strut assisted Z frame
<b>Wind rating</b>	Class 7

# Awnings & Tents



## Skypod Rapide

### SKP002 : Skypod Rapide roof top tent

- Introducing the SkyPod Rapide Roof Tent – a cutting-edge innovation in the world of outdoor adventure. This roof tent is designed to enhance your camping experience, providing convenience, comfort, and style in one compact package.
- The Skypod Rapide is lightweight and highly economical.
- Measures 2x1.2m and has a net weight of only 56kg, making it suitable for use not only with 4x4 vehicles but also with smaller vehicles. The SkyPod Rapide has a soft shell with a PVC cover that helps to protect it from the weather and is 100% waterproof. It comes with an aluminium telescopic ladder that can extend up to 2.3m in length. The Rapide includes a full dull silver heavy-duty fly with a PU coating that is both waterproof and UV resistant. Meshed bug windows and doors provide excellent ventilation and a great view.
- The high-density foam mattress is soft and cosy, ensuring a comfortable sleeping experience. Includes two shoe pockets and two inner mesh pockets for storing small items like keys and devices. It features a 5cm mattress with a skin-friendly thermal cover that offers a comfortable sleeping experience. There is even a sewn-in dimmable LED strip inside the roof tent for added convenience!
- The wind rating of the tent is Class 7 – which is upto 26 MPH

<b>Inner size (cm)</b>	200 x 140 x 75/120
<b>Closed Size (cm)</b>	223 x 160 x 28
<b>Total weight (kg)</b>	56
<b>Sleeping Capacity</b>	2 - 3
<b>Weight Capacity (kg)</b>	300

<b>Internal material</b>	190G Rip-Stop Polycotton with P/U 2000mm HH
<b>External material</b>	220D Rip-Stop Poly-Oxford with Silver Coating and P/U 3,000mm
<b>Mattress</b>	Mattress: 5cm High Density Foam + 5cm EPE
<b>Frame</b>	Extruded Aluminium Alloy
<b>Wind rating</b>	Class 7

# Awnings & Tents



## Skypod Lite

### SKP003 : Skypod Lite roof top tent

- Say hello to the Skypod Lite Roof Tent. Right up there when it comes to compact convenience in our new range of rooftop tents.
- Compact and lightweight, the Skypod Lite Roof Tent is crafted for those seeking the thrill of exploration whilst travelling 'lite'. Its streamlined silhouette and sleek profile make it the perfect companion for smaller vehicles and adventurers prioritising a simple and agile setup.
- The wind rating of the tent is Class 7 – which is up to 26 MPH
- The Skypod Lite can accommodate up to 2 people and weighs only 34 kilograms, making it extremely lightweight. It can be set up in just 5 minutes and is suitable for any vehicle, it makes an ideal choice for smaller vehicles. Skypod Lite is designed to be compact, taking up minimal roof rack space. It has a large eave and full rain fly cover, providing excellent rain protection. Two big mesh bug windows and one rear window allow for good ventilation and prevent insects and flies from entering your space. The mattress is 3cm thick and made of high-density foam, ensuring a comfortable sleeping experience. Skypod Lite also comes with a telescopic aluminium ladder that can support up to 150kgs.

<b>Inner size (cm)</b>	110 x 127 x 32
<b>Closed Size (cm)</b>	120 x 212 x 95
<b>Total weight (kg)</b>	34
<b>Sleeping Capacity</b>	1 - 2
<b>Weight Capacity (kg)</b>	300

<b>Internal material</b>	600D Rip-Stop Poly Oxford with PU 2000mm
<b>External material</b>	210D Rip-Stop Poly-Oxford with Silver Coating and PU 3,000mm, UPF50+
<b>Mattress</b>	Mattress: 3cm High Density Foam + 4cm EPE foam
<b>Flooring</b>	210D rip-stop Poly Oxford PU coated 2000mm HH
<b>Frame</b>	Extruded Aluminium Alloy in black
<b>Wind rating</b>	Class 7

# Awnings & Tents



## SkyPod Annex For Lair and Rapide

### SKP201: Annex for Lair and Rapide

- The Annex adapts to vehicle heights between 170–225 cm and features three doors for easy access, making it highly convenient and flexible. Its multifunctional design includes full seam taping for water resistance, an optional back wall for added privacy, and a removable floor for easy cleaning and adaptability.
- Adds a large practical living space
- Easy set up within seconds
- Three doors for easy entrance
- Fits vehicle heights between 170-225cm
- Multifunctional design
- Full seam tape for water resistance
- Optional back wall and removable floor
- Material : 210D rip-stop Oxford coated PU
- Ratings: 3000 mm HH, UPF 50+
- Pole : Fibreglass aluminium, telescopic poles.

<b>Annex Size (cm)</b>	305 x 365 x 240
<b>Pack Size (cm)</b>	127 x 22 x 2211.5
<b>Weight (kg)</b>	11.5



## Dometic PW1100 T6 multivan kit 2.6M Anthracite

9620001375

- Single person set up
- Tension rafter can be stowed in the front rail to save space
- Patented slide-out support legs
- S-flow housing design has no visible screws
- EasyLock Flipper to secure the support legs
- Strong, one-piece awning cloth has no welding seams
- Many vehicle-specific adapters available

<b>Drive assembly operation type</b>	Manual
<b>Width</b>	2600 mm
<b>Cloth Colour</b>	Horizon grey
<b>Colour</b>	Anthracite
<b>Projection</b>	2000 mm

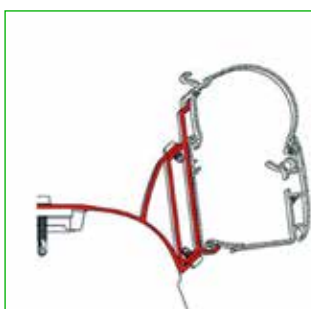

## Dometic VW T5/T6 multivan 3 piece bracket

9103104118

- Tailor-made for VW T5 and T6 Multivan
- Made for PW 1100 and PW 1500 wall awnings

<b>Depth</b>	60 mm
<b>Height</b>	150 mm
<b>Width</b>	150 mm
<b>Weight</b>	4 kg

# Awnings & Tents



## FREE CANOPY KIT

Includes a set of canopy poles to allow you to use any of the three panels as a sun canopy.

Kestral drive away tailgate awning (T5,6,6.1)  
Available in air or poled versions.

### A3530-MG : Poled

- Easy to use poled tailgate drive away awning.
- Minimal quick-fit pole system making it easy and quick to pitch.
- QTec75 pro very lightweight, very performant fabric.
- Quick drying, very lightweight, easy to fit and pitch.
- Roll up front door which can be used as a sun canopy with the included canopy pole kit.
- Clip in groundsheet for added weather protection.
- Tailgate opens up into the connection tunnel.

### A3530A-MG : Air

- Easy to use Air tailgate drive away awning.
- Featuring the Fast AirTec (FAT) system for quick and easy pitching.
- Lightweight, quick drying and durable QTec150 pro fabric for an extended lifespan.
- Very lightweight, easy to fit and pitch.
- Permanent built in ventilation for combating condensation and allowing air flow.
- Roll up front door which can be used as a sun canopy with the included canopy pole kit.
- Built in, fully tubbed groundsheet for added weather protection.
- Tailgate opens up into the connection tunnel.

<b>Main awning size (cm)</b>	300 x 300 x 230
<b>Tunnel Size (cm)</b>	140 x 210/230
<b>Weight (kg)</b>	14.2
<b>Fits (Tailgate models)</b>	T5, T6, T6.1
<b>Fabric</b>	75D / 6000 mm HH
<b>Frame</b>	Fibreglass
<b>Pack Size (cm)</b>	72 x 28 x 28

<b>Main awning size (cm)</b>	250 x 300 x 230
<b>Tunnel Size (cm)</b>	140 x 210/230
<b>Weight (kg)</b>	15
<b>Fits (Tailgate models)</b>	T5, T6, T6.1
<b>Fabric</b>	150D / 6000 mm HH
<b>Frame</b>	Fast Air Tech (FAT) Air beams
<b>Pack Size (cm)</b>	70 x 38 x 41

# Awnings & Tents

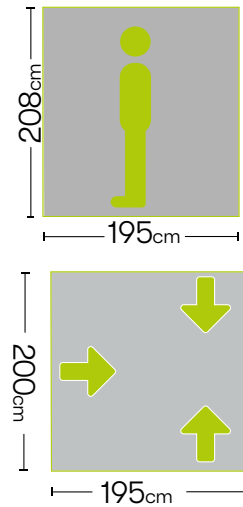

## Kite Tailgate VW camper van awning (T5,6,6.1) Tailgate vans only

### A3531-MG

- Does not require any poles, making it extremely easy and quick to pitch, so much so it can be done by a single person in a matter of minutes.
- QTec75 pro very lightweight, very performant fabric, which is very quick drying, very lightweight and easy to clean.
- Clip in, fully tubbed groundsheet for added weather protection.
- Tailgate opens up into the awning.

<b>Awning size (cm)</b>	200 x 195 x 208
<b>Weight (kg)</b>	4.6 kg.
<b>Fits (Tailgate models)</b>	T5, T6, T6.1
<b>Fabric</b>	75D / 6000 mm HH
<b>Frame</b>	Fibreglass
<b>Pack Size (cm)</b>	61 x 19 x 19



## Osprey camper van rear sun canopy (T5,6,6.1) Barn door vans only

### A3532-MG

- Instant canopy area at the back of your camper van.
- Heavyweight and premium fabric for better performance, longer life and added durability.
- So easy it can be fitted by a single person in a matter of minutes. Clips into position, no need for pegging.

<b>Canopy size (cm)</b>	80 x 160 cm
<b>Weight (kg)</b>	2.1 kg.
<b>Fits (Barn Door models)</b>	T5, T6, T6.1
<b>Fabric</b>	300D / 6000 mm HH
<b>Locking Pole</b>	Aluminium
<b>Pack Size (cm)</b>	112 x 9 x 9

# Awnings & Tents

## ANNEX AVAILABLE

**Optional annex available for the Eagle drive away awning (purchased separately).**



Eagle drive away awning (vehicles 180 - 210 or 240 - 270 high)  
Available in air or poled versions and low or high versions

**A3533-MG : Poled (low)**  
**A3534-MG : Poled (high)**

**A3533A-MG : Air (low)**  
**A3534A-MG : Air (high)**

- Easy to use poled drive away awning with annex option.
- Minimal quick-fit pole system making it easy and quick to pitch.
- QTec75 pro very lightweight, very performant fabric.
- Quick drying, very lightweight, easy to fit and pitch.
- Rain safe canopy over main door.
- Built in, fully tubbed groundsheet for added weather protection.
- Doors on all sides for maximum flexibility.

- Easy to use air drive away awning with annex option.
- Featuring the Fast AirTec (FAT) system for quick and easy pitching.
- Lightweight, quick drying and durable QTec150 pro fabric for an extended lifespan.
- Rain safe canopy over main door.
- Built in, fully tubbed groundsheet for added weather protection.
- Doors on all sides for maximum flexibility.

<b>Main awning size (cm)</b>	300 x 300 x 230
<b>Tunnel Size (cm)</b>	80 x 250/300
<b>Weight (kg)</b>	Low: 14.4   High: 14.8
<b>Fits (Height of vehicle)</b>	Low: 180 - 210 cm High: 240 - 270 cm.
<b>Fabric</b>	75D / 6000 mm HH
<b>Frame</b>	Fibreglass
<b>Pack Size (cm)</b>	77 x 31 x 30

<b>Main awning size (cm)</b>	300 x 300 x 230
<b>Tunnel Size (cm)</b>	80 x 250/300
<b>Weight (kg)</b>	Low: 16.4   High: 16.8
<b>Fits (Height of vehicle)</b>	Low: 180 - 210 cm High: 240 - 270 cm.
<b>Fabric</b>	300D / 6000 mm HH
<b>Frame</b>	Fast Air Tech (FAT) Air beams
<b>Pack Size (cm)</b>	77 x 42 x 36



# Awnings & Tents



Annex for Eagle drive away awning  
Fits all versions of the Eagle drive away awning

## A3535-MG

- Single pole system making it easy and quick to pitch.
- QTec75 pro very lightweight, very performant fabric.
- Quick drying, very lightweight, easy to fit and pitch.
- Simply zips onto the Eagle drive away awning to give you the perfect sleeping or storage pod.
- You can use up to 2 annexes on the same eagle awning.

<b>Annex size (cm)</b>	200 x 220 x 180
<b>Weight (kg)</b>	4.7 kg.
<b>Fits</b>	All eagle drive away awnings
<b>Fabric</b>	75D / 6000 mm HH
<b>Frame</b>	Fibreglass
<b>Pack Size (cm)</b>	65 x 20 x 18

## Screen House 4 Mini

### A5503-GR : Screen house 4 mini in grey

- Quest Tec75 very lightweight fabric.
- Single person pitch.
- Very lightweight.
- Small pack size.
- 60 seconds to erect.
- UV 50+ protection.
- Premium NoChill mesh PRO panels.
- Built in groundsheet.
- Premium hub system.
- Storm straps.
- Stable style door.
- Zipped carry bag.
- Quick drying.

<b>Size (cm)</b>	145 x 145 (+38)x 140/160
<b>Weight (kg)</b>	4.3
<b>Pack Size (cm)</b>	105 x 12 x 12



# Awnings & Tents



## The Original

The Quest screen house is the original, one person, one minute shelter. Often copied, but never equalled. It is simply the easiest and quickest shelter available today.

Quest Screen House Pro shelter and drive away awning  
Available in 4 or 6 sided versions

**A3000-GR : Screen House 4 Pro (grey)**  
**A3005 -GR: Screen House 6 Pro (grey)**

**A5505-GR : Screen House Pro Vehicle Connector**

- Featuring the Quest Tec 210 performance fabric
- Single person pitch: Easiest to use shelter on the market, with nothing to assemble, tension or inflate
- Full Quest No-Chill mesh sides, and double zipped front door, premium quality and strength throughout, plus full, sewn in Quest Tec 210 fabric sides with crystal clear windows and external blinds.
- Warmer in the wind and cooler in the sun
- U.V. coated protection giving a 50+ UV rating
- Premium hub : Latest generation frame system, maximising strength, whilst minimising weight and increasing performance
- Waterproof roof allowing the water to run off
- Extremely easy to put away into its own bag
- Side panels can be used in conjunction with canopy pole kit to create shaded areas outside of the screen house.
- Full accessory zip allowing for additional options (vehicle connector, screen shield and zipping screen house pro's together)

### Screen House 4 Pro

<b>Screen House size (cm)</b>	240 x 240 x 180/220
<b>Weight (kg)</b>	12.8
<b>Pack Size (cm)</b>	173 x 20 x 25

### Screen House 6 Pro

<b>Screen House size (cm)</b>	300 x 360 x 180/220
<b>Weight (kg)</b>	18
<b>Pack Size (cm)</b>	185 x 25 x 25

### VEHICLE CONNECTOR

Turn your screen house pro into a drive away awning with the screen house pro vehicle connector

### Vehicle Connector

<b>Size (cm)</b>	90 x 260 x 180/210
<b>Weight (kg)</b>	1.4 kg
<b>Pack Size (cm)</b>	72 x 16 x 16

# Awnings & Tents



**The universal annex ,  
Eris (standard) or Eris (premium)  
annexes can be attached on either side  
of the Orion drive away awning.**

Orion 2 300 air drive away awning  
Westfield Outdoors premium air drive away awning

12020413000002 : Main awning

12020413001002 : Low connector / tunnel

12020413002002 : Mid connector / tunnel

12020413004002 : Touring (Eriba) connector / tunnel.

12020413003002 : High connector / tunnel

- HydroTech cotton touch fabric.
- 2 Year warranty.
- Any season awning.
- Advanced air system.
- Single or multi point inflation.
- Single person pitch.
- Pano-View.
- Anti-Weather system.

- Internal blinds (zipped).
- UV 50+ Protection.
- Annex ready : can be extended by adding one (or two) of the Universal, Eris standard or Eris premium annexes.
- Ventilation side windows (very large) and built in ventilation
- Double beading.

- Deluxe floor ready.
- Removable panels.
- Zip on / off tunnel (purchased separately)
- Rain safe canopy.
- Includes storm poles (x2)
- Tinted windows

<b>Main awning size (cm)</b>	300 x 250 x 200
<b>Weight (kg)</b>	21.2
<b>Fabric</b>	300D
<b>Waterproof Rating</b>	10,000 mm HH
<b>UV Rating</b>	50+
<b>Frame</b>	Advanced Air System (AAS) Air
<b>Pack Size (cm)</b>	Beams 98 x 34 x 34

<b>Low Tunnel</b>	
<b>Tunnel Size (cm)</b>	65 x 260/300
<b>Pack Size (cm)   Weight (kg)</b>	84 x 18 x 18   4.96
<b>Fits (Height of vehicle)</b>	180 - 210 cm

<b>Mid Tunnel</b>	
<b>Tunnel Size (cm)</b>	90 x 300
<b>Pack Size (cm)   Weight (kg)</b>	62 x 24.5 x 24.5   4.7
<b>Fits (Height of vehicle)</b>	210 - 240 cm

<b>Touring (Eriba) Tunnel</b>	
<b>Tunnel Size (cm)</b>	65 x 300
<b>Pack Size (cm)   Weight (kg)</b>	84 x 17.5 x 17.5   6
<b>Fits (Height of vehicle)</b>	180 - 210 cm (Eriba caravan only)

<b>High Tunnel</b>	
<b>Tunnel Size (cm)</b>	90 x 300
<b>Pack Size (cm)   Weight (kg)</b>	62 x 25 x 25   4.94
<b>Fits (Height of vehicle)</b>	240 - 270 cm

# Awnings & Tents



Neptune 2 400 air drive away awning  
Westfield Outdoors premium air drive away awning

12020364000002 : Main awning

12020364026002 : High connector/ tunnel

12020364028002 : X High connector / tunnel

12020364024002 : Mid connector / tunnel

12020364030002 : XX High connector / tunnel

- HydroTech cotton touch fabric.
- 2 Year warranty.
- Any season awning.
- Advanced air system.
- Single or multi point inflation.
- Single person pitch.
- Pano-View.
- Anti-Weather system.
- Internal blinds (zipped).
- UV 50+ Protection.
- Annex ready : can be extended by adding one (or two) of the Universal, Eris standard or Eris premium annexes.
- Ventilation side windows (very large) and built in ventilation
- Double beading.
- Deluxe floor ready.
- Removable panels.
- Zip on / off tunnel (purchased separately)
- Rain safe canopy.
- Includes storm poles (x2)
- Tinted windows

<b>Main awning size (cm)</b>	400 x 250 x 220/240
<b>Weight (kg)</b>	34.1
<b>Fabric</b>	300D
<b>Waterproof Rating</b>	10,000 mm HH
<b>UV Rating</b>	50+
<b>Frame</b>	Advanced Air System (AAS) Air
<b>Pack Size (cm)</b>	Beams 100 x 50 x 50

<b>Mid Tunnel</b>	
<b>Tunnel Size (cm)</b>	90 x 400
<b>Fits (Height of vehicle)</b>	240 - 260 cm

<b>High Tunnel</b>	
<b>Tunnel Size (cm)</b>	90 x 400
<b>Fits (Height of vehicle)</b>	260 - 280 cm

<b>XHigh Tunnel</b>	
<b>Tunnel Size (cm)</b>	90 x 400
<b>Fits (Height of vehicle)</b>	280 - 300 cm

<b>XXHigh Tunnel</b>	
<b>Tunnel Size (cm)</b>	90 x 400
<b>Fits (Height of vehicle)</b>	300 - 320 cm

**The universal annex ,  
Eris (standard) or Eris (premium)  
annexes can be attached on either side  
of the Neptune drive away awning.**

# Awnings & Tents



## Zodiac 280 Air drive away awning Westfield Outdoors premium lite air drive away awning

12020240330000 : Main awning

12020240331800 : Low connector / tunnel

12020240332100 : Mid connector / tunnel

12020240332400 : High connector / tunnel

- HydroTech RipStop : A premium lightweight fabric that is thread dyed to stop fading, but also extremely strong and durable.
- Anti Condensation: The combination of the advanced coating and premium nature of the fabric means that condensation is kept to a minimum at all times.
- 2 Year warranty.
- Air Erect System (AES)
- Dual inflation beams.
- Single person pitch: This awning is easy enough to be pitched by one single person.
- Anti-Weather system.
- UV 50+ protection : Excellent protection from the sun's rays and also helps to protect the awning fabric and increase its lifespan.
- Pop up inner tent ready.
- Zip on / off tunnel.
- Lightweight.
- Internal blinds.
- Rain safe canopy.
- Removable panels.
- Annex ready - it can be extended by adding one or two Zodiac / Orion 1 annexes.

<b>Main awning size (cm)</b>	280 x 220 x 220
<b>Weight (kg)</b>	17.3
<b>Fabric</b>	150D Ripstop
<b>Waterproof Rating</b>	8,000 mm HH
<b>UV Rating</b>	50+
<b>Frame</b>	Air Erect System (AES) Air Beams
<b>Pack Size (cm)</b>	100 x 35 x 30

<b>Low Tunnel</b>	
<b>Tunnel Size (cm)</b>	65 x 260/280
<b>Pack Size (cm)   Weight (kg)</b>	84 x 18 x 18   3.78
<b>Fits (Height of vehicle)</b>	180 - 210 cm

<b>Mid Tunnel</b>	
<b>Tunnel Size (cm)</b>	90 x 280
<b>Pack Size (cm)   Weight (kg)</b>	62 x 25 x 25   3.3
<b>Fits (Height of vehicle)</b>	210 - 240 cm

<b>High Tunnel</b>	
<b>Tunnel Size (cm)</b>	90 x 280
<b>Pack Size (cm)   Weight (kg)</b>	62 x 25 x 25   3.5
<b>Fits (Height of vehicle)</b>	240 - 270 cm

**The Zodiac / Orion V1 annex can be attached on either side of the Zodiac drive away awning.**

# Awnings & Tents



Triton 300 Air arrive away awning  
Westfield Outdoors premium lite air drive away awning

12010273100001 : Main awning

12022233180210 : Low connector / tunnel

12022233210024 : Mid connector / tunnel

12022233240270 : High connector / tunnel

- HydroTech RipStop : A premium lightweight fabric that is thread dyed to stop fading, but also extremely strong and durable.
- Anti Condensation: The combination of the advanced coating and premium nature of the fabric means that condensation is kept to a minimum at all times.
- 2 Year warranty.

- Advanced Air System (AAS)
- Single or multiple inflation points - it is up to you.
- Single person pitch: This awning is easy enough to be pitched by one single person.
- Anti-Weather system.
- UV 50+ protection : Excellent protection from the sun's rays and also helps to protect the

awning fabric and increase its lifespan.

- Pop up inner tent ready.
- Zip on / off tunnel.
- Lightweight.
- Internal blinds.
- Rain safe canopy.
- All four side panels can be removed turning the drive away awning into an air shelter.

<b>Main awning size (cm)</b>	300 x 300 x 200/240
<b>Weight (kg)</b>	27.9
<b>Fabric</b>	150D Ripstop
<b>Waterproof Rating</b>	8,000 mm HH
<b>UV Rating</b>	50+
<b>Frame</b>	Advanced Air System (AAS) Air
<b>Pack Size (cm)</b>	Beams 100 x 35 x 37

<b>Low Tunnel</b>	
<b>Tunnel Size (cm)</b>	65 x 260/280
<b>Pack Size (cm)   Weight (kg)</b>	84 x 16.5 x 16.5   4.2
<b>Fits (Height of vehicle)</b>	180 - 210 cm

<b>Mid Tunnel</b>	
<b>Tunnel Size (cm)</b>	90 x 280
<b>Pack Size (cm)   Weight (kg)</b>	62 x 21.5 x 21.5   3.95
<b>Fits (Height of vehicle)</b>	210 - 240 cm

<b>High Tunnel</b>	
<b>Tunnel Size (cm)</b>	90 x 280
<b>Pack Size (cm)   Weight (kg)</b>	62 x 22 x 22   4.2
<b>Fits (Height of vehicle)</b>	240 - 270 cm

## Did you know ?

All 4 of the sides on the Triton can be removed, which allows it to be used as a simple sun shelter as well !

# Awnings & Tents

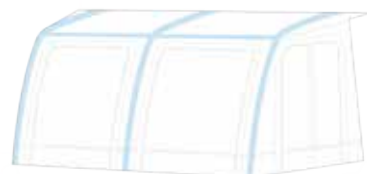
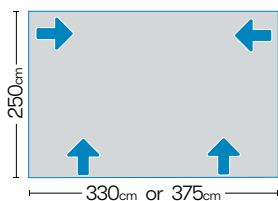
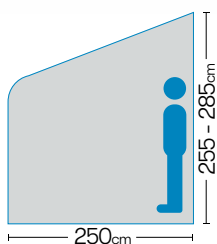

## Vega Air static motorhome awning Westfield Outdoors premium air awning

12020402850002 : Vega 2 for Motorhomes (330 wide)

12020375028502 : Vega 2 for Motorhomes (375 wide)

- HydroTech Cotton Touch : A premium heavyweight fabric that is thread dyed to stop fading, but also extremely strong and durable.
- Anti Condensation: The combination of the advanced coating and premium nature of the fabric means that condensation is kept to a minimum at all times.
- 2 Year warranty.
- Advanced Air System (AAS)
- Single inflation The entire awning is inflated

from one single point.

- Anti-Weather system.
- UV 50+ protection : Excellent protection from the sun's rays and also helps to protect the awning fabric and increase its lifespan.
- Annex ready : can be extended by adding one (or two) of the Universal, Eris standard or Eris premium annexes.
- Internal blinds.
- Unique centre beam configuration to allow

the sliding door on motorhomes to slide underneath the beam to avoid issues when using the awning.

<b>Fabric</b>	300D Cotton Touch
<b>Waterproof Rating</b>	10,000 mm HH
<b>UV Rating</b>	50+
<b>Frame</b>	Advanced Air System (AAS) Air Beams

### Vega 2 : 330 Dimensions

<b>Main awning size</b>	330 x 250 cm
<b>Weight</b>	32 kg (Pitching weight only 16 kg)
<b>Pack Size</b>	100 x 43 x 38 cm

### Vega 2 : 375 Dimensions

<b>Main awning size</b>	375 x 250 cm
<b>Weight</b>	32 kg (Pitching weight only 16 kg)
<b>Pack Size</b>	100 x 43 x 38 cm

**The universal annex ,  
Eris (standard) or Eris (premium) annexes  
can be attached on either side of the Vega  
awning.**

# Awnings & Tents

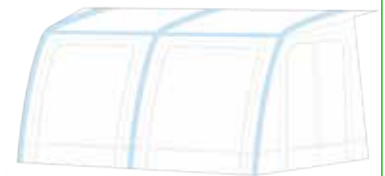
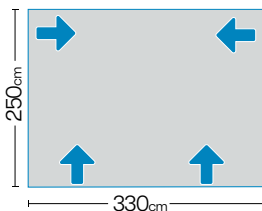
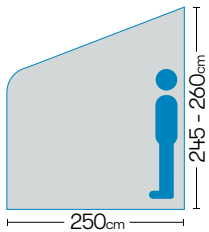

## Mars Air static motorhome awning Westfield Outdoors premium lite air awning

### 12020501000001 : Mars awning

- HydroTech RipStop : A premium lightweight fabric that is thread dyed to stop fading, but also extremely strong and durable. The fabric feels like cotton, but has the durability and ease of use of polyester.
- Anti Condensation: The combination of the advanced coating and premium nature of the fabric means that condensation is kept to a minimum at all times.
- 2 Year warranty.
- Advanced Air System (AAS)
- Single or multiple inflation points - it is up to you, there are three inflation points, but the entire awning can be inflated from any one, or you can use all three. It also makes deflation easier as you can allow the air to come out of all three points at the same time.
- Single person pitch: This awning is easy enough to be pitched by one single person.
- Anti-Weather system.
- UV 50+ protection : Excellent protection from the sun's rays and also helps to protect the awning fabric and increase its lifespan.
- Annex ready : can be extended by adding one (or two) of the Universal, Eris standard or Eris premium annexes.
- Internal blinds.

<b>Main awning size (cm)</b>	330 x 250
<b>Weight (kg)</b>	19.5 kg (Pitching weight only 9.8 kg)
<b>Fabric</b>	150D Ripstop
<b>Waterproof Rating</b>	8,000 mm HH
<b>UV Rating</b>	50+
<b>Frame</b>	Advanced Air System (AAS) Air
<b>Pack Size (cm)</b>	Beams 96 x 41 x 32 cm

**The universal annex,  
Eris (standard) or Eris (premium)  
annexes can be attached on either side  
of the Mars awning.**



# Awnings & Tents



## Eris Air Annex : premium annex for the Westfield awnings

**12020612000000 : Eris air annex (standard)**

**12020612000002: Eris air annex (premium)**

- The Eris air annex is an all window annex for various westfield awnings.
- It comes in standard version and premium, the difference is the fabric. The standard version features the HydroTech RipStop fabric (premium lightweight fabric) and the premium features the HydroTech Cotton Touch (premium heavyweight fabric).
- It features windows all on sides, all with zipped internal blinds.
- It also comes with with storm bars, which are optional for use, but included all the same.
- Both version fit the following awnings : Vega (all versions and sizes) , Pluto (all versions and sizes) , Ceres (all sizes) , Mars , Orion 2, Neptune 2, Galaxy 2 (all sizes).
- **Annex Size** : 180 x 210 x 190/195 cm
- **Pack size** - 95 x 30 x 30cm
- **Total weight**: 11kg
- **Fabric**: 150D Ripstop or 300D
- **Waterproof rating** 8,000 / 10,000 mm HH
- **UV Rating** : 50+



## Universal air annex

**12020370002000 : Universal (standard)**

**12020612000002: Orion 1 (pre 2023) and Zodiac**

- The universal air annex is an all panel (no windows) air annex for various Westfield awnings.
- It comes in standard and an Orion 1 (pre 2023) and zodiac version.
- The standard version fits the following awnings : Vega (all versions and sizes) , Pluto (all versions and sizes) , Ceres (all sizes) , Mars , Orion 2, Neptune 2, Galaxy 2 (all sizes).
- The Orion 1 (pre 2023) and Zodiac fits the Zodiac d and Orion 1 (pre 2023) drive away awnings only.
- **Annex Size** : 180 x 210 x 190/195 cm
- **Pack size** - 95 x 30 x 30cm
- **Total weight**: 11kg
- **Fabric**: 150D Ripstop or 300D
- **Waterproof rating** 8,000 / 10,000 mm HH
- **UV Rating** : 50+

# Awnings & Tents



## Westfield Shady Pro canopy.

12022235305000: 305 Width

12022235350000: 350 Width

12022235420000: 410 Width

12022235440000: 440 Width

12022235480000: 470 Width

12022235500000: 500 Width

12022235530000: 530 Width

12022235560000: 570 Width

- HydroTech RipStop : A premium lightweight fabric that is thread dyed to stop fading, but also extremely strong and durable. The fabric feels like cotton, but has the durability and ease of use of polyester.
- This is an extremely quick and easy to pitch canopy. Comes in various widths (all 220 cm deep) and comes complete with 3 adjustable king poles.



## Quest Falcon Airshield : quick and easy to use, extendable air windbreak. Available in a 3 pack, 1 pack or door.

A1038-MG : 3 Panel in mid grey

A1039-MG : 1 Panel in mid grey

A1038D-MG : Door Panel in mid grey

- |   |  |  |
|---|--|--|
| <ul style="list-style-type: none"> <li>• QuestTec 150 lightweight performance fabric</li> <li>• Falcon Air Technology (FAT) System</li> <li>• Lightweight</li> <li>• Single person pitch</li> <li>• Small pack size</li> <li>• Dual inflation/deflation points</li> </ul> | <ul style="list-style-type: none"> <li>• Independant panels</li> <li>• UV 50+ Protection</li> <li>• Large viewing windows</li> <li>• Each panel zips together</li> <li>• Extendable to any size</li> <li>• Use as many or as few panels as you like</li> </ul> | <ul style="list-style-type: none"> <li>• Each panel can be angled</li> <li>• Complete with pump (3 panel only)</li> <li>• Complete with a kador strip to connect to your caravan (3 panel only)</li> </ul> |
|---|--|--|

<b>1 Panel size (cm)</b>	160 x 140
<b>1 Panel Weight (kg)</b>	2.4
<b>1 Panel Pack Size (cm)</b>	50 x 20 x 18

<b>3 Panel size (cm)</b>	500 x 140
<b>3 Panel Weight (kg)</b>	7.75
<b>3 Panel Pack Size (cm)</b>	77 x 33 x 26

# Awnings & Tents



**Westfield Outdoors Windshield Pro : The strongest and most extendable premium windbreak system Available in a Main unit (3 panel), additional panel, door, weather canopy and dog bars**

**12020304000000 : Main Unit (3 Panel)**  
**12020304001000 : Additional Panel**

**12020304002000 : Door Panel**  
**A1043 : Weather Canopy**

**1293446070000 : Dog Bar**

- Lightweight and very small pack size.
- Pegs right down to the ground with no gap.
- Aluminium frame with a patented design
- Original free standing windbreak
- Windows
- No guy ropes or trip hazards, all the space is

- usable.
- Frame locks together forming an extremely strong and durable system that requires no guy lines.
- Extendable : You can join main units together, add additional panels, doors plus weather

- canopies.
- The windbreak can also be slide directly into a caravan awning channel.
- Super sleeves to allow the addition of a dog bar which creates a solid bar along the bottom of the windbreak.

**Main unit size (cm)** 480 x 140  
**Main unit Weight (kg)** 6  
**Main unit Pack Size (cm)** 110 x 25 x 15

**Additional Panel size (cm)** 160 x 140  
**Additional Panel Weight (kg)** 2.2  
**Additional Panel Pack Size (cm)** 110 x 15 x 10



**Westfield Narvi : Quick, easy to use premium air windbreak. Available in a 2 panel or 1 panel.**

**120203050000000 : Narvi 2 panels**

**120203050010000 : Narvi 1 Panel**

- 2 Year Warranty
- HydroTech RipStop premium fabric. Excellent strength, durability, anti-fading and built to last.
- Premium performance windbreak and fabrics.

- AAS Air system air beams gives you one all connected system, allowing for easy single inflation.
- Lightweight

- Extendable. You can connect as many of the Narvi's together as you like. They simple zip together to form a long and longer windbreak. Each unit can be angled separately.

**1 Panel size (cm)** 185 x 148  
**1 Panel Weight (kg)** 3.3  
**1 Panel Pack Size (cm)** 20 x 12 x 10

**2 Panel size (cm)** 456 x 148  
**2 Panel Weight (kg)** 6.5  
**2 Panel Pack Size (cm)** 80 x 25 x 22



MQL.CO.UK



FACEBOOK



X



WHATS APP



INSTAGRAM



LINKED IN



YOUTUBE



EMAIL